

GNC 420



Pilot's Guide and Reference





INTRODUCTION

Foreword

This manual is written for Main System Software version **2.17** or above, and is not suitable for earlier software versions.

GARMIN International, Inc., 1200 East 151st Street, Olathe, Kansas 66062 USA
Tel: 913/397.8200 Fax: 913/397.8282

GARMIN (Europe) LTD, Unit 5, The Quadrangle, Abbey Park, Romsey, Hampshire S051 9AQ, UK
Tel: 44/1794.519944 Fax: 44/1794.519222

GARMIN (Asia) Corp., No. 68, Jangshu 2nd Road, Shijr, Taipei County, Taiwan
Tel: 886/2.2642.9199 Fax: 886/2.2642.9099

Website address: www.garmin.com

© 1999-2000 GARMIN Corporation. All rights reserved. Except as expressly provided herein, no part of this manual may be reproduced, copied, transmitted, disseminated, downloaded or stored in any storage medium, for any purpose without the express prior written consent of GARMIN Corporation. GARMIN Corporation hereby grants permission to download a single copy of this manual and of any revision to this manual onto a hard drive or other electronic storage medium to be viewed and to print one copy of this manual or of any revision hereto, provided that such electronic or printed copy of this manual or revision must contain the complete text of this copyright notice and provided further that any unauthorized commercial distribution of this manual or any revision hereto is strictly prohibited.

Information in this document is subject to change without notice. GARMIN reserves the right to change or improve their products and to make changes in the content of this material without obligation to notify any person or organization of such changes or improvements.

Visit the GARMIN website for the latest updates and supplemental information concerning the operation of this and other GARMIN products.

GARMIN, GNC 420, Spell'N'Find, AutoLocate, PhaseTrac12 and AutoStore are trademarks of GARMIN and may only be used with permission.

NavData® is a registered trademark of Jeppesen, Inc.



INTRODUCTION

Cautions

NOTE: This device complies with Part 15 of the FCC limits for Class B digital devices. This equipment generates, uses, and can radiate radio frequency energy and, if not installed and used in accordance with the instructions, may cause harmful interference to radio communications. Furthermore, there is no guarantee that interference will not occur in a particular installation.

If this equipment does cause harmful interference, the user is encouraged to try to correct the interference by relocating the equipment or connecting the equipment to a different circuit than the affected equipment. Consult an authorized dealer or other qualified avionics technician for additional help if these remedies do not correct the problem.

Operation of this device is subject to the following conditions: (1) This device may not cause harmful interference, and (2) this device must accept any interference received, including interference that may cause undesired operation.

The GARMIN GNC 420 does not contain any user-serviceable parts. Repairs should only be made by an authorized GARMIN service center. Unauthorized repairs or modifications could void your warranty and authority to operate this device under Part 15 regulations.

CAUTION

The Global Positioning System is operated by the United States government, which is solely responsible for its accuracy and maintenance. The system is subject to changes which could affect the accuracy and performance of all GPS equipment. Although the GARMIN GNC 420 is a precision electronic NAVigation AID (NAVAID), any NAVAID can be misused or misinterpreted and therefore become unsafe.

Use the GNC 420 at your own risk. To reduce the risk of unsafe operation, carefully review and understand all aspects of this Owner's Manual and the Flight Manual Supplement, and thoroughly practice basic operation prior to actual use. When in actual use, carefully compare indications from the GNC 420 to all available navigation sources, including the information from other NAVAIDS, visual sightings, charts, etc. For safety, always resolve any discrepancies before continuing navigation.

The altitude calculated by the GNC 420 is geometric height above mean sea level and could vary significantly from altitude displayed by pressure altimeters in aircraft. GPS accuracy may be degraded by the U.S. Department of Defense imposed Selective Availability (SA) program. With "SA" on, GPS altitude may be in error by several hundred feet. Never use GPS altitude for vertical navigation.

GPS receivers operate by receiving and decoding very low power radio signals broadcast by satellites. It is possible that in some situations other radio equipment or electronic equipment used in close proximity to a GPS receiver may create electromagnetic interference (EMI) which may affect the ability of the GPS receiver to receive and decode the satellite signals. In such event, the interference may be reduced or eliminated by switching off the source of interference or relocating equipment.

The Jeppesen database incorporated in the GNC 420 must be updated regularly in order to ensure that its information is current. Updates are released every 28 days. A database information packet is included in your GNC 420 package.

Pilots using an out-of-date database do so entirely at their own risk.

Accessories & Packing List

Congratulations on choosing the finest, most advanced panel mount IFR navigation/communication system available. The GNC 420 represents GARMIN's commitment to provide accurate, easy-to-use avionics for all of your flying needs.

Before installing and getting started with your unit, please check to see that your package includes the following items. If any parts are missing or damaged, please see your GARMIN dealer immediately.

Standard Package:

- GNC 420 Unit & NavData® Card
- GPS Antenna
- Installation Rack & Connectors
- Pilot's Guide & Quick Reference Guide
- Database Subscription Packet
- Warranty Registration Card

Your GARMIN dealer will perform the installation and configuration of your new GNC 420. After installation, the NavData® card will already be installed into the correct slot on the front of the unit (see Appendix A). The GNC 420 will be secured in the installation rack with the proper wiring connections performed. Have your dealer answer any questions you may have about the installation—such as location of antennas or any connections to other equipment in the panel.



To obtain accessories for your GNC 420, please contact your GARMIN dealer.

The GNC 420 display lens is coated with a special anti-reflective coating which is very sensitive to skin oils, waxes, and abrasive cleaners. It is very important to clean the lens using an eyeglass cleaner which is specified for anti-reflective coatings (one suitable product is Wal-Mart® Lens Cleaner) and a clean lint-free cloth.

Help us to better support you by completing our on-line registration today! Registration ensures you will be notified of product updates, new products and provides for lost or stolen unit tracking. Have the serial number of your GNC 420 handy and connect to our website (www.garmin.com). Look for the Product Registration link on the home page.



INTRODUCTION

Warranty

GARMIN is fully committed to your satisfaction as a customer. If you have any questions regarding the GNC 420, please contact our customer service department at:

*GARMIN International, Inc.
1200 East 151st Street
Olathe, KS 66062-3426
(913) 397-8200
FAX (913) 397-8282*

*To obtain warranty service, call the GARMIN Customer Service department for a returned merchandise tracking number. The unit should be securely packaged with the tracking number clearly marked on the outside of the package, and sent freight prepaid and insured to a GARMIN warranty service station. A copy of the original sales receipt is required as proof of purchase for warranty repairs. GARMIN retains the exclusive right to repair or replace the unit or software or offer a full refund of the purchase price at its sole discretion. **SUCH REMEDY SHALL BE YOUR SOLE AND EXCLUSIVE REMEDY FOR ANY BREACH OF WARRANTY.***

GARMIN Corporation warrants this product to be free from defects in materials and workmanship for one year from the date of purchase. GARMIN will, at its sole option, repair or replace any components that fail in normal use. Such repairs or replacement will be made at no charge to the customer for parts or labor. The customer is, however, responsible for any transportation costs. This warranty does not cover failures due to abuse, misuse, accident or unauthorized alteration or repairs.



THE WARRANTIES AND REMEDIES CONTAINED HEREIN ARE EXCLUSIVE, AND IN LIEU OF ALL OTHER WARRANTIES EXPRESSED OR IMPLIED, INCLUDING ANY LIABILITY ARISING UNDER WARRANTY OF MERCHANTABILITY OR FITNESS FOR A PARTICULAR PURPOSE, STATUTORY OR OTHERWISE. THIS WARRANTY GIVES YOU SPECIFIC LEGAL RIGHTS, WHICH MAY VARY FROM STATE TO STATE.

IN NO EVENT SHALL GARMIN BE LIABLE FOR ANY INCIDENTAL, SPECIAL, INDIRECT OR CONSEQUENTIAL DAMAGES, WHETHER RESULTING FROM THE USE, MISUSE OR INABILITY TO USE THIS PRODUCT OR FROM DEFECTS IN THE PRODUCT. SOME STATES DO NOT ALLOW THE EXCLUSION OF INCIDENTAL OR CONSEQUENTIAL DAMAGES, SO THE ABOVE LIMITATIONS MAY NOT APPLY TO YOU.

PART ONE: INTRODUCTION

Foreword	i
Cautions	ii
Accessories/Packing List	iii
Warranty	iv
Table of Contents	v-vi
Takeoff Tour	1-20

PART TWO: REFERENCE

Section 1: Communicating with the GNC 420	21
COM frequencies	
Active and standby frequencies	
Section 2: NAV Page Group (GPS navigation)	27
Using page groups and selecting the desired page	
Using the default NAV and map pages	
Section 3: Direct-to Navigation	49
Using the  key	
Section 4: Flight Plans ( key and FPL page group)	54
Creating and using flight plans	
Retrieving and editing stored flight plans	
Section 5: Approaches, Departures and Arrivals ( key)	66
Selecting and flying non-precision/precision approaches	
Selecting and using departures (SIDs) and arrivals (STARs)	



CONVENTIONS USED IN THIS MANUAL

A circled number (e.g., “**8**”) will appear next to many of the illustrations shown along the side of a page. This number refers back to a specific step on the same page (or in rare instances, to a step on the following page).

When more than one option is possible within a procedure, the procedures are described using an “a”/“b” convention with the same numbering (e.g., “3a” and “3b” for two step#3 options). This same convention is used when multiple procedures are listed on the same page and illustrations are provided for the steps described in one or both procedures (e.g., “**3**a” and “**3**b”).

A highlighted “NOTE” area appears on many pages to point out additional information or items of particular importance related to a given subject.



INTRODUCTION

Table of Contents





To quickly and easily locate information on specific tasks, please refer to the Index on page 173.

Section 6: WPT Page Group (Waypoint/database information)	86
Finding and viewing airport location, runway and frequency data	
Finding and viewing navaid information	
Creating user-defined waypoints	
Section 7: NRST Page Group (Nearest airports, etc.)	111
Viewing nearest listings for airports, navaids and airspaces	
Displaying frequencies for nearest flight service (FSS) and center	
Section 8: AUX page group (Flight Planning and Unit Settings)	123
Section 9: Messages, Abbreviations & Navigation Terminology	150
Appendix A: NavData® Card Use	163
Appendix B: Specifications	164
Appendix C: Map Datums	165
Appendix D: Troubleshooting Q & A	167
Appendix E: Index	173



Key and Knob Functions

The GNC 420 is designed to make operation as simple as possible. The key and knob descriptions on the next three pages provide a general overview of the primary function(s) for each key and knob. This Takeoff Tour section is intended to provide a brief overview of the primary functions of your GNC 420. Experiment with the unit and refer to the Reference sections for more information.

Left-hand Keys and Knobs

-  The COM power/volume knob controls unit power and communications radio volume. Press momentarily to disable automatic squelch control.
-  The large left knob is used to tune the megahertz (MHz) value of the standby frequency for the communications transceiver.
-  The small left knob is used to tune the kilohertz (kHz) value of the standby frequency for the communications transceiver.
-  The COM flip-flop key is used to swap the active and standby COM frequencies. Press and hold to select emergency channel (121.500 MHz).

Right-hand Keys and Knobs

-  The range key allows you to select the desired map scale. Use the up arrow side of the key to zoom out to a larger area, or the down arrow side to zoom in to a smaller area.
-  The direct-to key provides access to the direct-to function, which allows you to enter a destination waypoint and establishes a direct course to the selected destination. See Section 3.

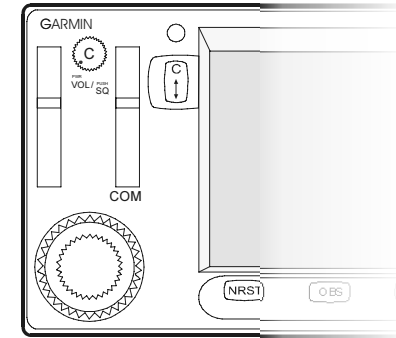

Left-hand Keys and Knobs

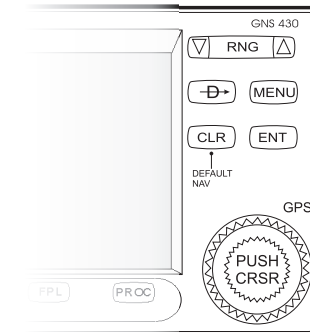

Right-hand Keys and Knobs

TAKEOFF TOUR

Key and Knob Functions

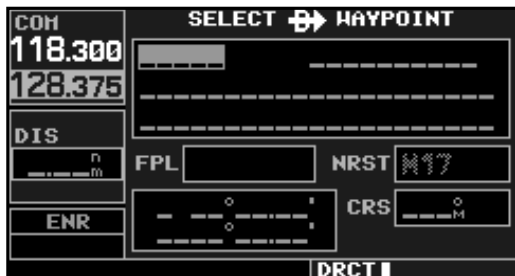

Data is entered using the large and small knobs. Experiment with them to become efficient at entering data. This will greatly reduce the amount of time spent operating the GNC 420 in flight.



MENU

The menu key displays a context-sensitive list of options. This options list allows you to access additional features or make settings changes which relate to the currently displayed page.

CLR

The clear key is used to erase information or cancel an entry. Press and hold this key to immediately display the Default Navigation Page (see pages 10 and 26), regardless of which page is currently displayed.

ENT

The enter key is used to approve an operation or complete data entry. It is also used to confirm information, such as during power on.



The large right knob (CRSR) is used to select between the various page groups: NAV, WPT, AUX or NRST. With the on-screen cursor enabled, the large right knob allows you to move the cursor about the page.



The small right knob (CRSR) is used to select between the various pages within one of the groups listed above. Press this knob momentarily to display the on-screen cursor. The cursor allows you to enter data and/or make a selection from a list of options.

TAKEOFF TOUR

Key and Knob Functions

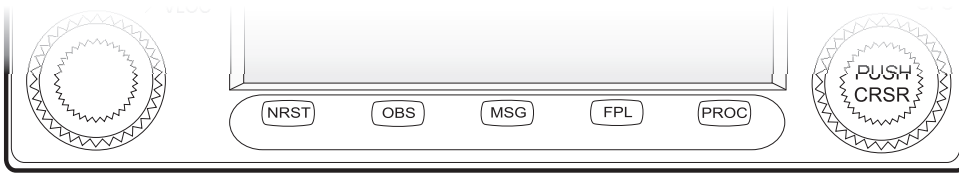

Bottom Row Keys

NRST

The NRST key displays the nearest airports page. Then, rotating the small right knob (PUSH CRSR) steps through the NRST pages.

OBS

The OBS key is used to select manual or automatic sequencing of waypoints. Pressing the OBS key selects OBS mode, which will retain the current “active to” waypoint as your navigation reference even after passing the waypoint (i.e., prevents sequencing to the next waypoint). Pressing the OBS key again will return to normal operation, with automatic sequencing of waypoints. Whenever OBS mode is selected, you may set the desired course to/from a waypoint using the OBS Page, or an external OBS selector on your HSI or CDI.

MSG

The message key is used to view system messages and to alert you to important warnings and requirements. See Sections 8 and 9 for more information on messages and unit settings.

FPL

The flight plan key allows you to create, edit, activate and invert flight plans, as well as access approaches, departures and arrivals. A closest point to flight plan feature is also available from the flight plan key. See Section 4 for more information on flight plans.

PROC

The procedures key allows you to select and remove approaches, departures and arrivals from your flight plan. When using a flight plan, available procedures for your departure and/or arrival airport are offered automatically. Otherwise, you may select the desired airport, then the desired procedure.

COH		NEAREST AIRPORT			
		APT	BRG	DIS	APR
125.000		24N	182°	38.1 ⁿ	VFR
119.900		mul	122.900	rwy 7500 ^f	
DIS		KALS	080°	40.1 ⁿ	ILS
125 ⁿ		uni	122.800	rwy 8800 ^f	
ENR		5V9	221°	43.5 ⁿ	VFR
		mul	122.900	rwy 3100 ^f	
NRST 00000000					

scroll bar

Whenever the GNC 420 is displaying a list of information that is too long for the display screen, a scroll bar will appear along the right-hand side of the display. The scroll bar graphically indicates the number of additional items available within the selected category.

Simply press the small right knob (PUSH CRSR) to activate the cursor and rotate the large right knob (©) to scroll through the list.

TAKEOFF TOUR

Power On



The welcome page appears when the GNC 420 is turned on. During the time this screen is displayed, the GNC 420 performs a self test to ensure proper operation.



The database confirmation page shows the effective and expiration dates of the Jeppesen database on the NavData Card.

The GARMIN GNC 420 provides you accurate navigational data and communication capability, along with non-precision approach certification in the IFR environment. The Takeoff Tour is designed to familiarize you with the operation of the GNC 420—including powering up the unit, changing frequencies, entering data, performing a simple direct-to, selecting IFR procedures and provides a limited introduction to using flight plans. In addition, this section briefly covers the default navigation, map and frequency pages available as part of the NAV page group. These pages will be used for most of your in-flight navigation.

The Takeoff Tour assumes that the unit and antennas have been properly installed and you have not changed any of the GNC 420's default settings. If you have changed any of the factory default settings (position format, units of measure, selectable fields, etc.), the pictures shown here may not exactly match what you see on your GNC 420. Prior to using your GNC 420 for the first time, we recommend that you taxi to a location that is well away from buildings and other aircraft so the unit can collect satellite data without interruption.

Powering up the GNC 420

The GNC 420's power and COM volume are controlled using the  (power/volume) knob at the top left corner of the unit. Rotating it clockwise will turn unit power on and increase the COM radio volume. After turning the unit on, a *welcome page* will be displayed while the unit performs a self test.

The *database confirmation page* will appear next, which shows the current database information on the NavData card (with the valid operating dates, cycle number and database type indicated). The database is updated every 28 days, and must be current for approved instrument approach operations. Information on database subscriptions is available inside your GNC 420 package.

To acknowledge the database information, press the  key.

TAKEOFF TOUR

Instrument Panel Self Test

Check CDI/HSI, RMI and other instruments to verify these indications.

Fuel Figures: May be entered manually if no sensor present.

Should match current OBS course selection

Select to Set Fuel Level to Full Capacity

Select to display Checklists Page

Once the database has been acknowledged, the *instrument panel self-test* page will appear. Check for the following indications on other instruments:

- Course deviation - half left / no flag
- TO/FROM flag - TO
- Bearing to destination - 135°
- Distance to dest. - 10.0 nautical mi.
- All external annunciators (if installed) - on
- Glidescope - half up / no flag
- Time to destination - 4 minutes
- Desired track - 149.5°
- Ground speed - 150 knots

The *instrument panel self-test* page indicates the currently selected OBS course, fuel capacity (CAP), fuel on board (FOB), and fuel flow (FF). The fuel capacity, fuel on board, and fuel flow may be manually entered if your installation does not include connection to sensors which automatically provide these figures.

To enter fuel capacity, fuel on board, or fuel flow figures (if not provided by sensors):

1. Rotate the large right knob (⊖) to select the "CAP", "FOB", or "FF" field.
2. Rotate the small (⊖) and large (⊖) right knobs to enter the desired figure, then press **ENT**.

Enter the fuel capacity, fuel on board, or fuel flow figures directly onto the appropriate field of the *instrument panel self-test* page. These figures will automatically be provided if your installation includes connection to external sensors.

TAKEOFF TOUR

Fuel On Board & Checklists



Select “Set Full Fuel?” to set fuel on board (FOB) to full capacity.



Select “GoTo Chklist?” to display the checklist page and any available checklists. The GNC 420 can hold up to nine checklists with up to 30 entries in each checklist.

The instrument panel self-test page includes the selections to set fuel on board (FOB) to full capacity and access the checklists page. This allows you to quickly set fuel to full limits and display any checklists you’ve entered, such as start-up or take-off checklists.

To set fuel on board to full (if not provided by sensor):

1. Rotate the large right knob (⊖) to highlight “Set Full Fuel?”.
2. Press **ENT** and verify that fuel on board (FOB) now matches the fuel capacity (CAP) figure. Fuel on board will now be reduced, over time, based on the fuel flow (FF) figure.

To view the checklists page:

1. Rotate the large right knob (⊖) to highlight “Go To Chklist?” and press **ENT**.
2. Rotate the large (⊖) right knob to select the desired checklist, then follow the steps on page 133 to execute each step in the selected checklist.
3. Once you complete the desired checklist(s), press the small right knob (⊖) to return to the checklists page. Press the small right knob (⊖) return to normal operation on the satellite status or map pages.

Once you’ve verified instrument operation with the instrument panel self-test page displayed, rotate the large right knob (⊖) to highlight “OK” (if not already highlighted), and press the **ENT** key.

The satellite status page will appear as the GNC 420 begins to collect satellite information. An ‘Acquiring’ status message will be displayed on the satellite status page, and the signal strength of any satellites received will appear as “bar graph” readings. This is a good indication that you are receiving signals and a position fix will be determined. Following the first-time use of your GNC 420, the time required for position fix will vary - usually from one to two minutes.

TAKEOFF TOUR

Acquiring Satellites & Viewing Messages

If the unit can only obtain enough satellites for 2D navigation (no altitude), the unit will use the altitude provided by your altitude encoder (if one is connected).

If the GNC 420 has not been operated for a period of six months or more, it may have to 'Search the Sky' to collect new data. This means the unit is acquiring satellite data to establish almanac and satellite orbit information, which can take 5 to 10 minutes. The *satellite status page* will display a 'Search Sky' status, and the message annunciator (MSG), above the **MSG** key, will also flash to alert you of a system message, 'Searching the Sky'.

To view a system message, press **MSG**.



Message Page

The *message page* will appear and display the status or warning information applicable to the receiver's current operating condition.

To return to the previous page after viewing a message, press **MSG** again.



The *satellite status page* shows the ID numbers for the satellites and the relative signal strength of each satellite received (as a "bar graph" reading).

'Search Sky' indicates that satellite almanac data is not available or has expired (if the unit hasn't been used for six months or more). The data will be recollected from the first available satellite.

The 'INTEG' annunciator (bottom left corner of the screen) indicates that satellite coverage is insufficient to pass built-in integrity monitoring tests. In the example above, not enough satellites are being received to determine a position.

TAKEOFF TOUR

Selecting COM Frequencies

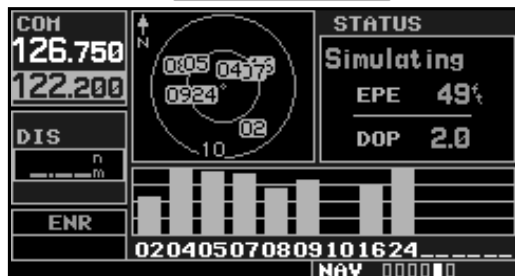

Satellite status page with cursor in the COM window.

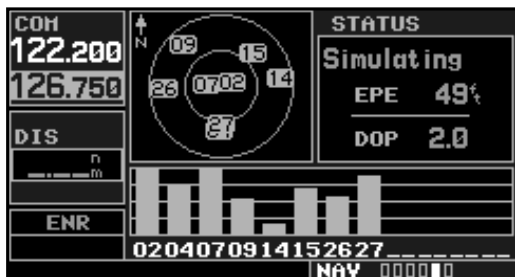

To switch the active and standby frequencies, press the **↕** key. Switching the active and standby frequencies will not remove the cursor from the COM window.

While the GNC 420 is acquiring a position, let's take a minute to dial in the active and standby frequencies you'll be using for the first phase of your flight. The GNC 420's display is divided into separate 'windows' (or screen areas), including a COM window, data field and the GPS window (the right 3/4 of the display).

Active Frequency on top &

Standby on bottom
(highlighted by cursor)

COM Window

User Selectable
Data field

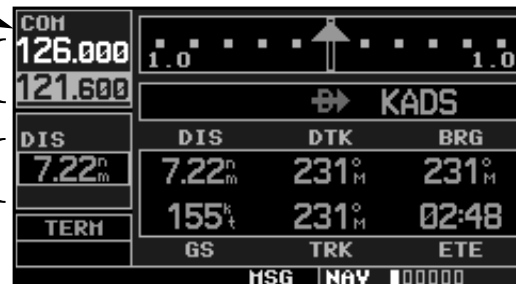

GPS Window

To select the active frequency, you must first enter the frequency in the standby field, and use the **↕** key to move it to the active field.

To change the standby communication frequency:

1. Rotate the large left knob (⦿) to select the MHz, and the small left knob (●) to select the kHz of the desired frequency.
2. Press the **↕** key to place the standby communication frequency in the active field.

Once you've entered the active frequency, simply repeat step 1 above, to enter the standby frequency.

After the GNC 420 acquires satellites and computes a position, the *map page* will appear automatically.

The *map page* displays your present position (using an airplane symbol) relative to nearby airports, VORs, NDBs, intersections, user waypoints and airspace boundaries—and your route is displayed as a solid line. Data fields for destination waypoint (WPT), distance to waypoint (DIS), desired track (DTK) and ground speed (GS) appear on the right hand side of the display.

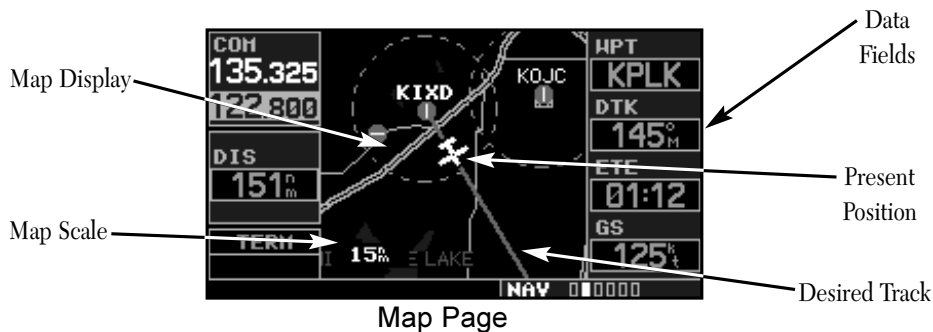

These fields are user selectable (see page 38 for more information) to allow you to configure the unit to your own preferences. Available settings include: altitude, bearing, enroute safe altitude, estimated time of arrival, minimum safe altitude, and ground track. See Section 9 for definitions of these navigation terms.



The map page combines a moving map display and navigation data for complete situational awareness. Map setup pages are provided to designate the maximum scale at which each map feature will appear. These settings provide an automatic decluttering of the map (based upon your preferences) as you adjust the scale.

While viewing the map page, you can quickly declutter and remove many of the background map details by pressing the **CLR** key (repeatedly) until the desired detail is depicted.

To change the map scale, press the **▼** or **▲** side of the **RNG** key.

TAKEOFF TOUR

NAV Pages & Page Groups



The bottom right corner of the screen indicates which page group is currently being displayed (e.g., NAV or WPT), the number of screens available within that group (indicated by square icons) and the placement of the current screen within that group (indicated by a highlighted square icon). To select a different page within the group, rotate the small right knob (PUSH OPEN).

*Seven NAV Pages are available when the GNC 420 installation includes connection to traffic and/or weather information sources. See 400 Series Pilot's Guide Addendum, part number 190-00140-10.

The *map page* is one of six pages available under the NAV group:

- Default NAV page
- NAVCOM page
- Satellite status page
- Map page
- Position page
- Vertical navigation page

To select the desired NAV page, rotate the small right knob (PUSH OPEN) until the desired page is displayed.

If you are currently viewing a page which is not part of the NAV group, you can quickly return to the NAV group using the CLR key.

To select the NAV group and display the default NAV page, press and hold CLR.

MAIN PAGE GROUPS

NAV	WPT	AUX
6 available pages (see list above)	10 available pages (see list on pg. 86)	4 available pages (see list on pg. 123)

In addition to the NAV group of pages, additional groups of pages are available for waypoint information (WPT) and auxiliary (AUX) functions such as flight planning or unit settings.

To select the desired page group, rotate the large right knob (PUSH OPEN) until a page from the desired group is displayed.

To select the desired page within the group, rotate the small right knob (PUSH OPEN) until the desired page is displayed.

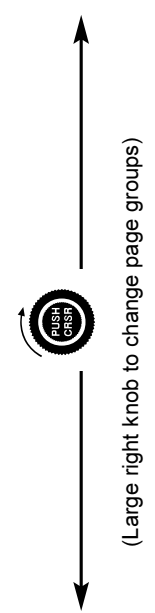

NAV Group

Default NAV Map NAVCOM Position Satellite Status VNAV

WPT Group

Airport Location Airport Runway Airport Frequency Airport Approach Airport Arrival Airport Departure Intersection NDB VOR User Waypoint

AUX Group

Flight Planning Utility Setup 1 Setup 2

Selection of any main page is performed using the large (Ⓢ) and small (Ⓜ) right knobs. The large right knob (Ⓢ) selects the page group: NAV, WPT, or AUX. The small right knob (Ⓜ) selects the desired page within a group. To quickly select the default NAV page, press and hold CLR.

TAKEOFF TOUR

Direct-To Navigation



Confirm the selected direct-to destination by highlighting “Activate?” and pressing **ENT**.

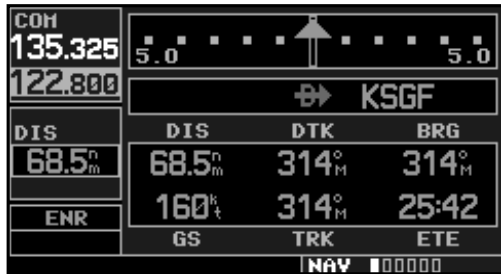

Once a direct-to destination is selected, press and hold **CLR** to display the default NAV page.

Destination
Waypoint
Identifier Field

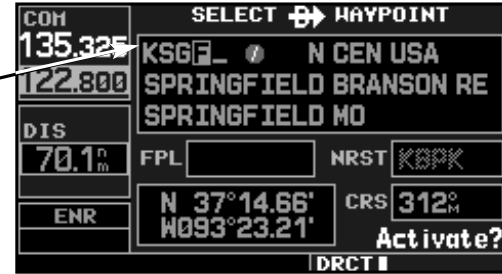

Select Direct-To Waypoint Page

“Activate?”
Function Field

The GNC 420 can use direct point-to-point navigation to guide you from takeoff to touchdown, even in the IFR environment. Once a destination is selected, the unit will provide speed, course and distance data based upon a direct course from your present position to your destination. A destination can be selected from any page with the **B>** (direct-to) key.

To select a direct-to destination:

1. Press the **B>** key. The select direct-to waypoint page will appear with the destination field highlighted.
2. Rotate the small right knob (PUSH) to enter the first letter of the destination waypoint identifier. The destination waypoint may be an airport, VOR, NDB, intersection or user waypoint, as long as it is in the database or stored in memory as a user waypoint.
3. Rotate the large right knob (C) to the right to move the cursor to the next character position.
4. Repeat steps 2 and 3 to spell out the rest of the waypoint identifier.
5. Press **ENT** to confirm the identifier. The “Activate?” function field will be highlighted.
6. Press **ENT** to activate a direct-to course to the selected destination.

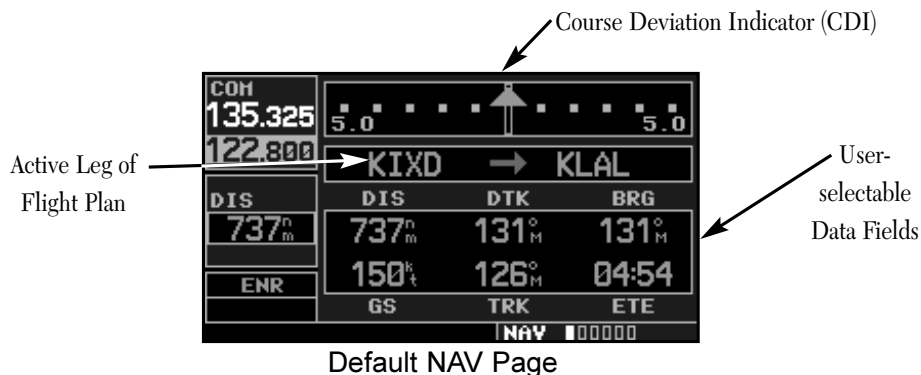

During most flights, the *default NAV*, *map* and *NAVCOM* pages will be the primary pages used for navigation. The *default NAV page* displays a graphic course deviation indicator (CDI), the active leg of your flight plan (as defined by the current “from” and “to” waypoints), and six user-selectable data fields. The default settings for these fields are distance to waypoint (DIS), desired track (DTK), bearing to waypoint (BRG), ground speed (GS), ground track (TRK) and estimated time en route (ETE). See Section 9 for definitions of these navigation terms. The *default NAV page* is selected using the steps described on page 10.

From the *default NAV page*, simply rotate the small right knob (Ⓢ) to display the *map page* (see page 7) and again to display the *NAVCOM page*. The *NAVCOM page* displays the available frequencies (communications and navigation) for the departure airport, any en route airports which are included in your flight plan, and the final destination airport. When using the direct-to function, frequencies will be listed for the airport nearest to your starting position and the destination airport.

To display the frequency list for the desired flight plan or direct-to airport:

1. Push the small right knob (Ⓢ) to activate the cursor on the airport identifier field (in the GPS window).

{continued}



The data fields on the default NAV page may be custom-tailored to your preferences. A menu selection is provided to “Change Fields?”

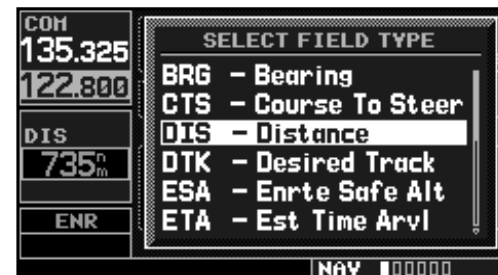

The large right knob (Ⓢ) is used to select the data field you wish to change. Then use the small right knob (Ⓢ) to display a list of data options and select the desired data item.

TAKEOFF TOUR

NAVCOM Page



The navigation/communications (NAVCOM) page provides a complete list of airport frequencies at your departure, en route and arrival airports. To place a frequency from this list on standby, highlight the desired frequency and press **ENT**.

To display frequencies for a different airport along your flight plan, press the small right knob (PUSH CRSR) to highlight the airport identifier field. Rotate the small right knob (PUSH CRSR) to display the list of airports within your flight plan. Continue rotating the small right knob (PUSH CRSR) to select the desired airport and press **ENT**.

2. Rotate the small right knob (PUSH CRSR) to display the list of airports (departure, arrival and en route) for your flight plan or direct-to. Continue to rotate the small right knob (PUSH CRSR) until the desired airport is selected.
3. Press **ENT** to display the frequency list for the selected airport.

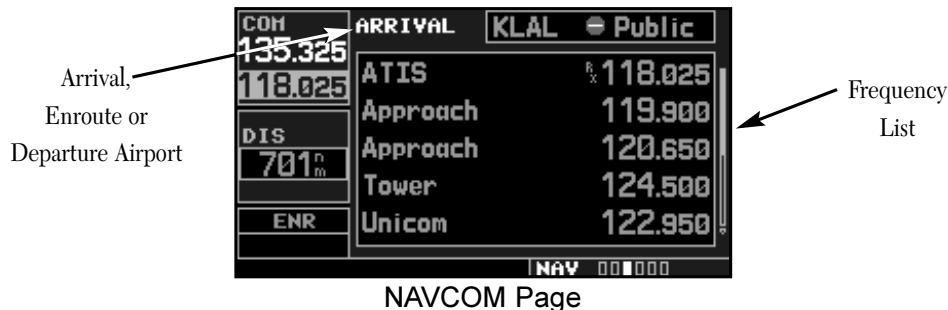

A frequency listed on the NAVCOM page can be quickly transferred to the standby field of the COM window. (NAV frequencies are shown for reference only.) This time saving process prevents having to “re-enter” a frequency already displayed elsewhere on the screen.

To select a communication frequency:

1. Push the small right knob (PUSH CRSR) to activate the cursor in the GPS window.
2. Rotate the large right knob (PUSH CRSR) to select the desired frequency from the list.
3. Press **ENT** to transfer the selected frequency to the standby field in the COM window. COM frequencies will automatically go to the standby field of the COM transceiver.
4. To activate the selected frequency, press the **↕** key

Once the direct-to or flight plan is confirmed, the whole range of instrument procedures is available to you. Departures (SIDs), arrivals (STARs), non-precision and precision approaches are stored within the NavData card and available using the **PROC** (procedures) key.

To display the procedures page, press **PROC**.

The steps required to select and activate an approach, departure or arrival are identical. In this introductory section, we'll show examples of the steps required to select an approach, but keep in mind the same process also applies to departures and arrivals.

To select an approach, departure or arrival:

1. Rotate the small right knob (PUSH CREW) to select the desired option ("Select Approach?", "Select Arrival?" or "Select Departure?") from the procedures page.
2. Press **ENT** to display a list of available procedures for the arrival (when using approaches or STARs) or departure (when using SIDs) airport.
3. Rotate the small right knob (PUSH CREW) to select the desired procedure and press **ENT**.
4. For approaches, a window appears to select the desired initial approach fix (IAF) or provide a "vectors" option to select just the final course segment of the approach. Rotate the small right knob (PUSH CREW) to select the desired option and press **ENT**. (The "vectors" option extends the final inbound course beyond the final approach fix, allowing you to intercept the final course segment beyond its normal limits.)
5. For departures and arrivals, a window appears to select the desired transition. Rotate the small right knob (PUSH CREW) to select the desired option and press **ENT**.

In your flight plan or direct-to, the departure or arrival airport is replaced with the sequence of waypoints contained within the selected procedure.



Press the **PROC** key to display the procedures page. Rotate the large right knob (C) to select the desired option.

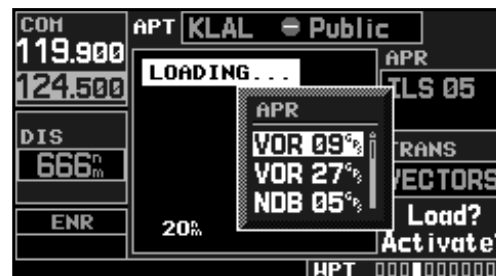

A window will appear to select the desired procedure. Use the large right knob (C) to make your selection.

TAKEOFF TOUR

Nearest Airport Emergency Search

COM	NEAREST AIRPORT			
	APT	BRG	DIS	APR
119.900	KSGF	165° _M	7.9 _n	ILS
124.500		twr 119.900	rwy 7000 _{ft}	
DIS	3DW	135° _M	12.3 _n	VFR
112 _n		uni 122.800	rwy 4000 _{ft}	
ENR	M17	012° _M	13.9 _n	VFR
		uni 123.000	rwy 3400 _{ft}	
HSG NRST 00000000				

To display a list of nearby airports, press the **NRST** key to select the nearest airport page.

COM	NEAREST AIRPORT			
	APT	BRG	DIS	APR
119.900	KSGF	167° _M	9.5 _n	ILS
124.500		twr 119.900	rwy 7000 _{ft}	
DIS	M17	014° _M	12.3 _n	VFR
110 _n		uni 123.000	rwy 3400 _{ft}	
ENR	3DW	139° _M	13.6 _n	VFR
		uni 122.800	rwy 4000 _{ft}	
HSG NRST 00000000				

To scroll through the list, press the small right knob (CURR), then rotate the large right knob (CRS).

The NRST page group provides detailed information on the nine nearest airports, VORs, NDBs, intersections and user-created waypoints within 200 nm of your current position. In addition, pages are also provided to display the five nearest center (ARTCC/FIR) and Flight Service Station (FSS) points of communication, plus alert you to any special-use (SUA) or controlled airspace you may be in or near.

To display the NRST pages:

1. Press the **NRST** key. The nearest airport page will appear.
2. Rotate the small right knob (CURR) to select the desired NRST page.

The *nearest airport page* (shown at left) is one of eight pages available under the NRST group:

- Nearest airport page
- Nearest intersections page
- Nearest NDB page
- Nearest VOR page
- Nearest user waypoints page
- Nearest ARTCC page
- Nearest FSS page
- Nearest airspace page

You may examine both the communication frequencies and runway information directly from the nearest airport page. As discussed earlier for the *NAVCOM page* (see page 14), you may also place any displayed frequency into the standby COM field by highlighting the frequency with the cursor and pressing **ENT**.

To view additional information for a nearby airport:

1. Press the small right knob (PUSH CRSR) to activate the cursor.
2. Rotate the large right knob (CRS) to select the desired airport from the list.
3. Press ENT to display waypoint (WPT) information pages for the selected airport.
4. To display runway and frequency information, press (PUSH CRSR) to remove the cursor and rotate the small right knob (PUSH CRSR) to display the desired information page.

The *nearest airport page* may be used in conjunction with the direct-to (B>) key to quickly set a course to a nearby facility in an in-flight emergency. Selecting a nearby airport as a direct-to destination will override your flight plan or cancel a previously selected direct-to destination. (You'll still have the option of returning to your flight plan by cancelling the direct-to. See page 53.)

To select a nearby airport as a direct-to destination:

From the nearest airport page...

1. Press the small right knob (PUSH CRSR) to activate the cursor.
2. Rotate the large right knob (CRS) to select the desired airport from the list.
3. Press B>, ENT and ENT (again) to navigate to the nearby airport.

From an airport information page...

1. Press B>, ENT and ENT (again) to navigate to the nearby airport.



Additional information for a nearby airport is available by highlighting an identifier on the list and pressing ENT.

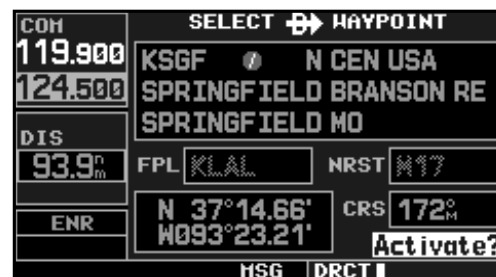

To select a nearby airport as a new destination, highlight its identifier, press B>, ENT and ENT (again).

TAKEOFF TOUR

Special-use and Controlled Airspace



When an airspace alert occurs, the message (MSG) annunciator will flash. Press **MSG** to view the alert message.



To view additional information about the airspace, select the nearest airspace page. Detailed information is available by highlighting the airspace name and pressing **ENT**.

The last page in the NRST group, the *nearest airspace page*, provides information for up to nine controlled or special-use airspaces near or in your flight path. Airspace information appears on this page based upon the same criteria used for airspace alert messages. Nearby airspace information and airspace alert messages are provided according to the following conditions:

- If your projected course will take you inside an airspace within the next ten minutes, the message “**Airspace ahead -- less than 10 minutes**” will appear.
- If you are within two nautical mile of an airspace and your current course will take you inside, the message “**Airspace near and ahead**” will appear.
- If you are within two nautical miles of an airspace and your current course will **not** take you inside, the message “**Near airspace less than 2nm**” will appear.
- If you have entered an airspace, the message “**Inside airspace**” will appear.

By default, airspace alert messages are turned off. When turned on, the message (MSG) annunciator located directly above the **MSG** key will flash to alert you to the airspace message. (See page 140 for information on enabling airspace alert messages.)

To view an airspace alert message:

1. Press the **MSG** key. The message page appears with the alert message.
2. Press **MSG** again to return to the previous display.

Note that the airspace alerts are based upon three-dimensional data (latitude, longitude and altitude) to avoid nuisance alerts. The alert boundaries for controlled airspace are also sectorized to provide complete information on any nearby airspace. Additional information about a nearby airspace—such as controlling agency, frequency and floor/ceiling limits—is available from the *nearest airspace page* (see page 119 and illustrations shown at left).

TAKEOFF TOUR

Flight Plans

The GNC 420 lets you create up to 20 flight plans, with up to thirty-one waypoints in each flight plan. Flight plans are created, edited and activated using the **FPL** key. The FPL page group includes two pages: the *active flight plan page* and the *flight plan catalog*. The *active flight plan page* provides information and editing features for the flight plan currently in use (referred to as “flight plan 00”). The *flight plan catalog* serves as the main page for creating new flight plans, as well as editing or activating previously created flight plans.

Since using flight plans is arguably one of the more complex features of the GNC 420, we’ll only discuss it briefly here—focusing on creating a new flight plan and activating it to use for navigation. After reading through this brief introduction, answers to additional questions you may have about flight plans can be found in the reference section, starting on page 54.

To create a new flight plan:

1. Press the **FPL** key and rotate the small right knob (Ⓜ) to select the flight plan catalog.
2. Press the **MENU** key to display the flight plan catalog options.
3. Rotate the large right knob (Ⓢ) to select “Create New Flight Plan?” and press **ENT**.
4. The cursor will appear on the first waypoint identifier field (located directly below “WAY-POINT”). Use the large (Ⓢ) and small (Ⓜ) right knobs to enter the identifier of the first waypoint in the flight plan. (The small knob is used to select the desired letter or number and the large knob is used to move to the next character space.)
5. Press **ENT** once the identifier has been selected. The cursor will move to the next blank waypoint identifier field.
6. Repeat steps 4 and 5, above, until all waypoints for the flight plan have been entered.

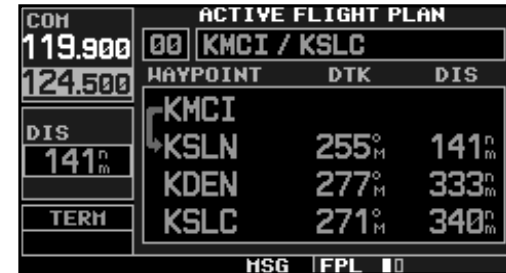

Active flight plan page with flight plan currently in use.



To create a new flight plan, select “Create New Flight Plan?” from the flight plan catalog options.

TAKEOFF TOUR

Flight Plans and Additional Reading



Enter the identifier for each airport and/or navaid into the flight plan in the same sequence you wish to fly.



Select "Activate Flight Plan?" from the page menu to begin using the new flight plan.

Once the flight plan is created, it may be activated from an options window. Activating the flight plan will place it into "flight plan 00" (a copy of it will still reside in the original catalog location) and replaces any flight plan which currently exists in "flight plan 00."

To activate the new flight plan:

1. Press the **MENU** key to display the flight plan catalog options.
2. Rotate the small right knob (**PUSH**) to select "Activate Flight Plan?" and press **ENT**.

This Takeoff Tour is intended to provide a brief introduction of the GNC 420's major features. The Reference section of this manual describes these features, and others, in additional detail. Use the reference section, as needed, to learn or review the details regarding a particular feature. The Index (beginning on page 173) may be used to quickly locate the information you want within the reference section.

Now that you're familiar with the basics, some suggested reading within the Reference section includes:

- Flight plan features - see page 54
- Waypoint information pages (database information) - see page 86
- IFR procedures - see page 66
- Unit settings (configuring the unit to your preferences) - see page 123

If you're unable to locate the information you need, we're here to help! GARMIN's Customer Service staff is available during normal business hours (U.S. Central time zone) at the phone and fax numbers listed on page iv. You can also reach us by mail (see page iv) or at our web site address: www.garmin.com.

Section 1

Communicating with the GNC 420

The GNC 420 features a digitally-tuned VHF COM radio that provides a seamless transition from communication to navigation, bringing the two most important functions in flying together in one panel-mounted unit. The GNC 420's COM radio operates in the aviation voice band, from 118.000 to 136.975 MHz, in 25 kHz steps (default). For European operations, a COM radio configuration to allow for 8.33 kHz steps is also provided (see pages 148-149).

Volume

COM radio volume is adjusted using the **C** knob. Rotate the **C** knob clockwise to increase volume, or counterclockwise to decrease volume.

Squelch

The COM radio features an automatic squelch, providing maximum sensitivity to weaker signals while rejecting many localized noise sources. You may wish to override this automatic squelch function when listening to a distant station or when setting the desired volume level. The **C** knob allows you to disable the automatic squelch and keep the COM audio open continuously.

To override the automatic squelch, press the **C** knob momentarily. Press **C** again to return to automatic squelch operation.

COM Radio Volume Auto Squelch

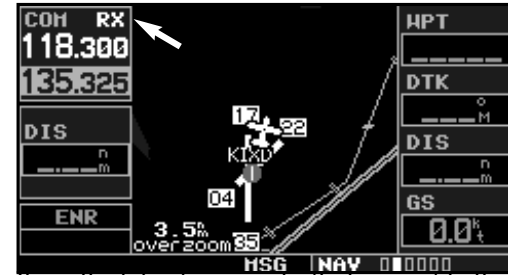

Press the **k** knob momentarily to override the automatic squelch. Note the “RX” receive indication when receiving a station.



“TX” appears at the upper right corner of the screen while transmitting.

1

COM Tuning Cursor Active/Standby Freqs



Tuning cursor in the COM window. Use the small (⊖) and large (⊕) left knobs to dial in the desired standby frequency.



Once the standby frequency is selected, use the (⊕) (flip-flop) key to make the frequency active for transmit and receive operations.

COM Window and Tuning

Communication frequencies are selected with the tuning cursor in the *standby* COM frequency field, and using the small (⊖) and large (⊕) left knobs to dial in the desired frequency. The standby frequency always appears below the *active* frequency. The active frequency is the frequency currently in use for transmit and receive operations.

A frequency may also be quickly selected from the database by simply highlighting the desired frequency on any of the main pages and pressing the (ENT) key. This process is referred to as *auto-tuning*. Once a frequency is selected in the standby field, it may be transferred to the active frequency by pressing the (⊕) key.

While receiving a station, an “RX” indication appears in the upper right corner of the COM window—to the immediate right of “COM”. A “TX” indication appears at this location while you are transmitting.

NOTE

Except for the Emergency Channel function, (see page 26) the active frequency cannot be accessed directly—only the standby frequency will be highlighted by the tuning cursor.

To select a COM frequency:

1. Rotate the large left knob (⊕) to select the desired megahertz (MHz) value. For example, the “118” portion of the frequency “118.300”.
2. Rotate the small left knob (⊖) to select the desired kilohertz (kHz) value. For example, the “.300” portion of the frequency “118.300”.

To make the standby frequency the active frequency, press the (⊕) (flip flop) key.

Auto-Tuning

The GNC 420's auto-tune feature allows you to quickly select any database frequency in the GPS window as your standby frequency. Any COM frequency displayed in the GPS window can be transferred to the standby COM frequency field, with a minimum of keystrokes required. The following are some examples of selecting COM frequencies from some of the main GPS pages.

To select a COM frequency for a nearby airport:

1. Select the nearest airport page from the NRST page group. (See page 111.) Press and hold **NRST**, to display the nearest airport page.
2. Press the small right knob (PUSH CRSR) momentarily to place the cursor on the airport identifier field of the first airport in the list. If you wish to select another airport, rotate the large right knob (ENT) to highlight the desired airport.
3. The nearest airport page displays the *common traffic advisory frequency* (CTAF) for each listed airport. To select this frequency, rotate the large right knob (ENT) to highlight the desired airport's CTAF frequency and press **ENT** to place the frequency in the standby field of the COM window.
4. To display the entire list of frequencies for a nearby airport and select from that list, start with the desired airport highlighted on the nearest airport page (as described in step 3 above), then press **ENT**. Now press the small right knob (PUSH CRSR) momentarily to remove the cursor and rotate the small right knob (PUSH CRSR) to display the frequency list. Press the small right knob (PUSH CRSR) momentarily to reactivate the cursor and rotate the large right knob (ENT) to highlight the desired frequency. Press **ENT** to place the highlighted frequency in the standby COM window field.



Auto-Tuning from Nearest Airport Page

COM	NEAREST AIRPORT			
119.900	APT	BRG	DIS	APR
122.900	SNQ1	266 ^o _M	7.1 ⁿ _m	VFR
	mul	122.900	rwy	4400 ^{ft}
DIS	KSQ3	030 ^o _M	20.3 ⁿ _m	VFR
12.1 ⁿ _m	-----	-----	rwy	2400 ^{ft}
	KHLC	079 ^o _M	21.0 ⁿ _m	VFR
ENR	mul	122.900	rwy	4000 ^{ft}
	NRST 00000000			

Nearest airport page with common traffic advisory frequency (CTAF) for the closest airport highlighted.

COM	APT	KAPA	Public	Done?
120.300	ATIS			120.300
118.900	Clearance			128.600
	Ground			121.800
DIS	Tower			118.900
99.8 ⁿ _m	Unicom			122.950
ENR				
	HPT 00000000			

From the nearest airport page, select the desired airport to show a more detailed listing of frequencies for that airport.

1

Auto-Tuning FSS or Center







Use the nearest FSS page to retrieve the frequency(s) for the nearest flight service station (FSS).







Use the nearest ARTCC page to quickly retrieve the frequency(s) for the nearest center (ARTCC) facility.

To select a COM frequency for a nearby flight service station (FSS):

1. Select the nearest flight service page from the NRST page group. (See page 111, or rotate the large right knob, , until the NRST pages appear. Then, if necessary, rotate the small right knob, , to display the desired NRST page.)
2. Press the small right knob () momentarily to place the cursor on the page.
3. Rotate the large right knob () to highlight the FSS frequency and press **ENT** to place the frequency in the standby field of the COM window.

To select a COM frequency for a nearby air route traffic control center (ARTCC):

1. Select the nearest center page from the NRST page group. (See page 111, or rotate the large right knob, , until the NRST pages appear. Then, if necessary, rotate the small right knob, , to display the desired NRST page.)
2. Press the small right knob () momentarily to place the cursor on the page.
3. Rotate the large right knob () to highlight the ARTCC frequency and press **ENT** to place the frequency in the standby field of the COM window.

To select a COM frequency for any airport in your flight plan:

1. Select the NAVCOM page from the NAV page group. (See page 27, or press and hold **CLR**, then rotate the small right knob, **PUSH CRSR**, until the NAVCOM page appears.)
2. Press the small right knob (**PUSH CRSR**) to place the cursor on the airport identifier field. To the left of this field appears *Departure*, *Enroute* or *Arrival*—depending on the placement of the displayed airport within your flight plan.
3. Rotate the small right knob (**PUSH CRSR**) to display a window listing the airports in your flight plan. Continue rotating the small right knob (**PUSH CRSR**) to select the desired airport.
4. Press **ENT** to return to the NAVCOM page with the frequencies for the selected airport.
5. Rotate the large right knob (**CRSR**) to highlight the desired frequency.
6. Press **ENT** to place the highlighted frequency in the standby COM window field.

To select a COM frequency for any airport in the database:

1. Select the airport frequencies page from the WPT page group. (See page 86, or rotate the large right knob, **CRSR**, to select the WPT page group. Then rotate the small right knob, **PUSH CRSR**, until the airport frequencies page appears.)
2. Press the small right knob (**PUSH CRSR**) to place the cursor on the airport identifier field.
3. Use the small (**PUSH CRSR**) and large (**CRSR**) right knobs to enter the identifier of the desired airport. Press **ENT** when finished.
4. Rotate the large right knob (**CRSR**) to highlight the desired frequency.
5. Press **ENT** to place the highlighted frequency in the standby COM window field.



Auto-Tuning from Flight Plan/Database



The NAVCOM page provides a frequency list for all the airports (departure, en route and arrival) along your active flight plan.

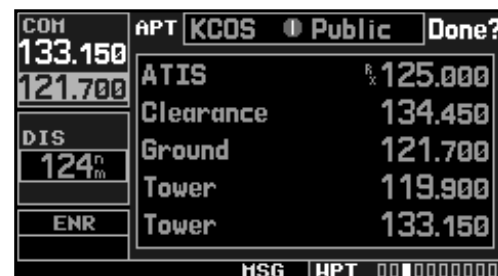

Use the airport frequencies page to retrieve a frequency list for ANY airport in the Jeppesen NavData database.

1

Emergency Channel Stuck Mic



Press and hold the  (flip-flop) key for two seconds to activate the 121.500 MHz emergency frequency.



A “COM push-to-talk key stuck” message appears to warn you of a stuck microphone. Transmitting is disabled after 35 seconds of continuous broadcasting.

Emergency Channel

The GNC 420’s emergency channel select provides a quick method of selecting 121.500 MHz as the active frequency in the event of an in-flight emergency. The emergency channel select is available whenever the unit is on, regardless of GPS or cursor status, or loss of the display.

To quickly tune and activate 121.500, press and hold  for approximately two seconds.

Stuck Microphone

As mentioned earlier, whenever the GNC 420 is transmitting, a “TX” indication will appear in the COM window. If the microphone is stuck or accidentally left in the keyed position, or continues to transmit after the key is released, the COM transmitter will automatically timeout (or cease transmitting) after 35 seconds of continuous broadcasting. You’ll also receive a “COM push-to-talk key stuck” message as long as the stuck condition exists.

Section 2

NAV Pages

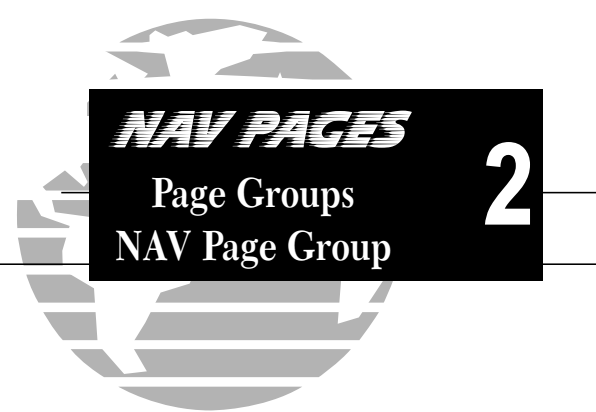

Main Page Groups

The GNC 420's main pages are divided into groups: NAV, WPT, and AUX. While viewing any of these pages, selection of another page is a simple selection process using the small (PUSH CRSB) and large (C) right knobs.

NAV
6 available pages (see list below)

WPT
10 available pages (see list on pg. 86)

AUX
4 available pages (see list on pg. 123)

To select the desired page group, rotate the large right knob (C) until a page from the desired group is displayed.

To select the desired page within the group, rotate the small right knob (PUSH CRSB) until the desired page is displayed.

NAV Page Group



The NAV page group includes six pages. While viewing any NAV page, rotate the small right knob (PUSH CRSB) to select a different NAV page. You may find this selection process convenient to cycle between the *default NAV* and *map pages*—two of the most frequently used pages. Other pages are provided to list frequencies for your flight plan, show your current position, display current satellite reception, and make vertical navigation settings.



The bottom right corner of the screen indicates which page group is currently being displayed (e.g., NAV or WPT), the number of screens available within that group (indicated by square icons) and the placement of the current screen within that group (indicated by a highlighted square icon). To select a different page within the group, rotate the small right knob (PUSH CRSB).



This part of the screen is also used to display the GNC 420's turn advisories (e.g., "Turn to 230°") and waypoint alerts (e.g., "Next DTK 230°") during flight plan and approach operations. See Section 5 for more information.

2

NAV PAGES Default NAV Page

The following symbols are used—on the default NAV page directly below the CDI—to depict the “active leg” of a flight plan or direct-to:

 Direct-To a Waypoint

 Course to a Waypoint, or Desired Course between Two Waypoints

 Procedure Turn

 Procedure Turn

 Vectors-To-Final

 DME Arc to the left

 DME Arc to the right

 Left-hand Holding Pattern

 Right-hand Holding Pattern

Default NAV Page

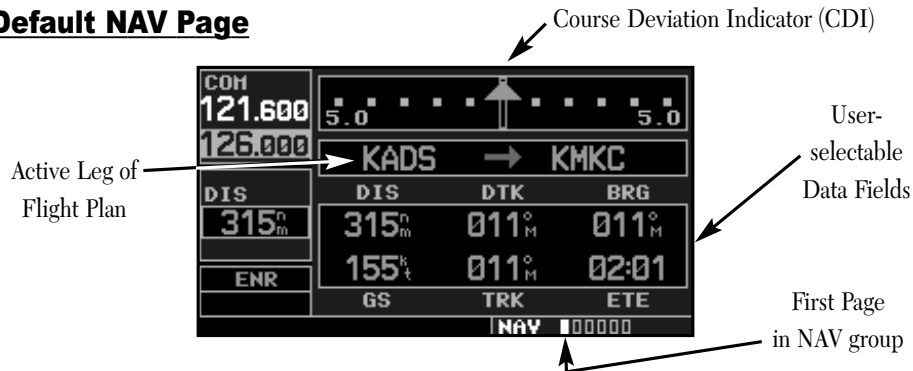

The first NAV page is the *default NAV page*. This page may be quickly selected from ANY page by using the **CLR** key.

To select the NAV group and display the default NAV page, press and hold **CLR**.

The *default NAV page* displays a graphic course deviation indicator (CDI) across the top of the page. Unlike the angular limits used on a mechanical CDI coupled to a VOR or ILS receiver, full scale limits for this CDI are defined by a GPS-derived distance (0.3, 1.0 or 5.0 nm), as indicated at both ends of the CDI. By default, the CDI scale will automatically adjust to the desired limits based upon the current phase of flight: en route, terminal area or approach. You may also manually select the desired scale setting as outlined on pages 141-143.

The graphic CDI shows your position at the center of the indicator, relative to the desired course (the moving course deviation needle). As with a traditional mechanical CDI, when you're off course simply steer toward the needle. The TO/FROM arrow in the center of the scale indicates whether you are heading to (an up arrow) the waypoint or if you have passed the waypoint (a down arrow).

NOTE

The GNC 420 always navigates TO a waypoint unless the OBS switch is set (preventing automatic waypoint sequencing), or you have passed the last waypoint in your flight plan.

Directly below the CDI appears the active leg of your flight plan, or the direct-to destination when using the **B>** key. This will automatically sequence to the next leg of your flight plan as you reach each interim waypoint. If no flight plan or direct-to destination has been selected, the destination field will remain blank.

Selecting Desired On-Screen Data

At the bottom of the *default NAV page* you'll find six user-definable fields which display the data you'll need as your flight progresses. By default these fields display: distance to destination (DIS), desired track (DTK), bearing to destination (BRG), ground speed (GS), ground track (TRK) and estimated time en route (ETE). However, each of these fields can be custom-tailored to your preferences by selecting a different data item. Available data items include:

- Bearing to destination (BRG)
- Distance to destination (DIS)
- En route safe altitude (ESA)
- Estimate time en route (ETE)
- Minimum safe altitude (MSA)
- Ground track (TRK)
- Cross track error (XTK)
- Course to steer (CTS)
- Desired track (DTK)
- Estimated time of arrival (ETA)
- Ground speed (GS)
- Track angle error (TKE)
- Vertical speed required (VSR)

If no flight plan or direct-to destination has been selected only speed, track, altitude and minimum safe altitude data may be displayed. All other data types will appear as blank lines—on the *default NAV page*—until a destination is selected.

To select a different data item for any data field:

1. Starting with the default NAV page, press the **MENU** key to display an options menu.
2. The "Change Fields?" option is already highlighted, so press **ENT** to select this option.
3. Use the large right knob (⊖) to highlight the data field you wish to change.
4. Rotate the small right knob (⊕) to display the list of available data items. Continue rotating the small right knob (⊕) to select the desired data item from the list.



1
2

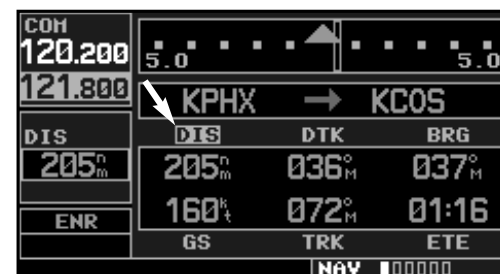

3

2

NAV PAGES

Map Page

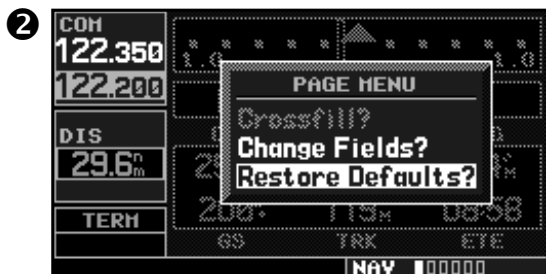

5. Press **ENT** to select the desired data item and return to the default NAV page.
6. Press the small right knob (**PUSH CRN**) momentarily to remove the cursor from the page.

Restoring Factory Settings

You can also quickly return all data field settings to their original factory settings.

To restore all six data fields to factory default settings:

1. Starting with the default NAV page, press the **MENU** key to display an options menu.
2. Rotate the large right knob (**CRN**) to highlight the "Restore Defaults?" option and press **ENT**.

Dual Unit Considerations

A "Crossfill?" option is also provided for the *default NAV page*. This option allows you to transfer a direct-to destination or flight plan to a second 400-series GARMIN unit. See page 58 for additional details on using the "Crossfill?" option.

Map Page

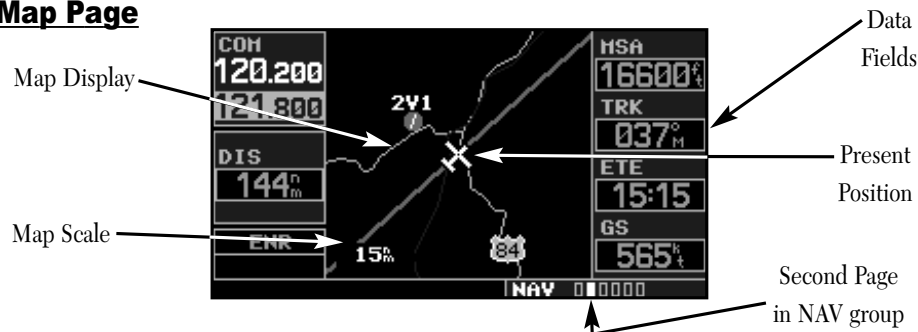

The second NAV page is the *map page*, which displays your present position using an airplane symbol, along with nearby airports, nav aids, user-defined waypoints, airspace boundaries, lakes, rivers, highways and cities.













NOTE

If the GNC 420 is unable to determine a GPS position, the present position (airplane) symbol will not appear on the map page.

NAV PAGES



Map Page

Different symbols are used to distinguish between waypoint types. The identifiers for any on-screen waypoints can also be displayed. (By default the indentifiers are enabled.) Special-use and controlled airspace boundaries appear on the map, showing the individual sectors in the case of Class B or Class C airspace. The following symbols are used to depict the various airports and navaids on the *map page*:

- | | | | |
|---|---|---|----------------------|
|  | Airport with hard surface runway(s); Primary runway shown |  | Intersection |
|  | Airport with soft surface runway(s) only |  | VORTAC |
|  | Private Airfield |  | TACAN |
|  | VOR |  | NDB |
|  | VOR/DME |  | Locator Outer Marker |
|  | DME | | |
|  | Localizer | | |

The map display can be set to 23 different scale settings from 500 feet to 2000 nautical miles (statute and metric units are also available). The scale is indicated in the lower left-hand corner of the map display, and represents the top-to-bottom distance covered by the map display.

To select a map scale:

1. Press the up arrow side of the  key to zoom out to a larger map area.
2. Press the down arrow side of the  key to zoom in to a smaller map area and more detail.

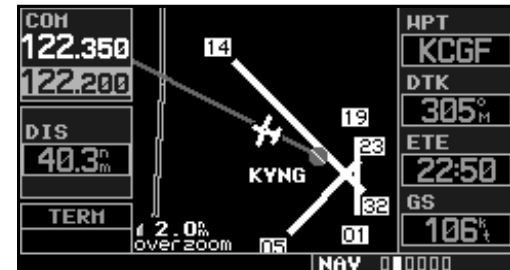
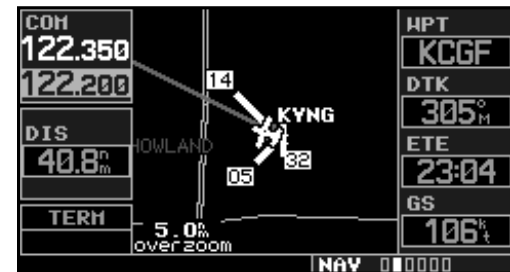

2

NAV PAGES

Map Page



The **CLR** key allows you to quickly declutter the map display, providing four levels of map detail. Note the “-1” and “-2” (“-3” is also provided) suffix designations above, indicating each successive declutter level.

An autozoom feature is available which will automatically adjust from an en-route scale of 2000 through each lower scale, stopping at a scale of 1.0 as you approach your destination waypoint. The autozoom feature is turned on/off from the map setup page described on page 36.

The *map page* also displays a background map showing lakes, rivers, coastlines, highways, railways and towns. When a map scale is selected below the lower limit at which the map detail was originally created, an “overzoom” indication will appear on the map display, below the scale reading. “Overzoom” indicates that the detail at this scale may not accurately represent actual conditions. If you continue to zoom in to lower scale settings, “overzoom” will be replaced with “no map” and the geographic detail is removed from the map display (but, the airport and navaid detail will remain).

The “Setup Map?” option (described on page 35) allows you to define the maximum scale at which each map feature will appear. This provides you with complete control to minimize screen clutter. You can also quickly remove items from the map using the **CLR** key.

To quickly declutter the map display, press the **CLR** key momentarily (as often as needed) to select the desired amount of map detail.

The right-hand side of the map page includes four user-selectable data fields. By default, the displayed data is: destination waypoint name (WPT), desired track (DTK), distance to destination waypoint (DIS) and ground speed (GS). Any of these data fields may be changed to display a different data type, as outlined on page 38. You may also remove the four data fields from the map to show a larger map image, as described on page 38.

Map Panning

Another *map page* function is panning, which allows you to move the map beyond its current limits without adjusting the map scale. When you select the panning function—by pressing the small right knob (PUSH CRSR) —a target pointer will appear on the map display. A window will also appear at the top of the map display showing the latitude/longitude position of the pointer, plus the bearing and distance to the pointer from your present position.

To select the panning function and pan the map display:

- 1a. Press the small right knob (PUSH CRSR) to activate the panning target pointer.
- 2a. Rotate the small right knob (PUSH CRSR) to move up (rotate clockwise) or down (counterclockwise).
3. Rotate the large right knob (CRSR) to move right (rotate clockwise) or left (counterclockwise).
4. To cancel the panning function and return to your present position, press the small right knob (PUSH CRSR).

When the target pointer is placed on an object, the name of that object will be highlighted (even if the name wasn't originally displayed on the map). This feature applies to airports, nav aids, user-created waypoints, roads, lakes, rivers—pretty much everything displayed on the map except route lines.

When an airport, navaid, or user waypoint is selected on the map display, you can review information about the waypoint or designate the waypoint as your direct-to destination.

To review information for an on-screen airport, navaid or user waypoint:

- 1b. Use the panning function (as described above) to place the target pointer on a waypoint.
- 2b. Press ENT to display the waypoint information page(s) for the selected waypoint.
3. Press CLR to exit the information page(s).

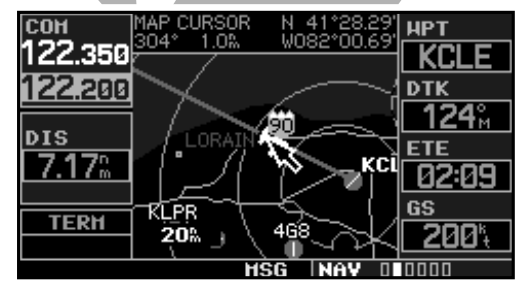

1 a



1 b

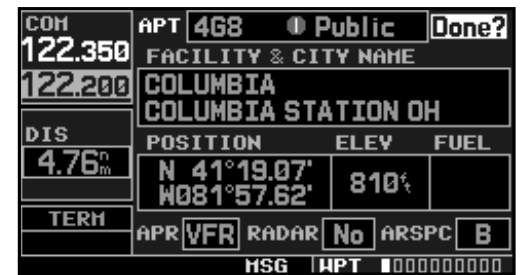

2 b

2

NAV PAGES

Map Page



Map Direct-To

To designate an on-screen airport, navaid or user waypoint as your direct-to destination:

- 1a. Use the panning function (see previous page) to place the target pointer on a waypoint.
2. Press \rightarrow to display the select direct-to waypoint page, with the selected waypoint already listed.
- 3a. Press ENT twice to confirm the selection and begin navigating to the waypoint.

The direct-to function can be used anywhere on the map. If nothing currently exists at the crosshair position, a new waypoint (called “+MAP”; shown at left) will be created at the target pointer location before the direct-to is initiated.

Airspace Information on the Map

When a special-use or controlled airspace boundary appears on the map display, you can quickly retrieve information—such as floor/ceiling limits and controlling agency—directly from the map.

To view airspace information for an on-screen special-use or controlled airspace:

- 1b. Use the panning function (see previous page) to place the target pointer on an open area within the boundaries of an airspace. If the area is congested and it is difficult to select an open area, you may need to zoom in or press CLR to make the selection easier.
2. Press ENT to display an options menu.
- 3b. “Review Airspace?” should already be highlighted, if not select it with the small right knob (CLR). Press ENT to display the airspace information page for the selected airspace.
4. To display the com frequency(s) for the controlling agency, rotate the large right knob (ENT) to highlight “Frequencies?” and press ENT. Press CLR to return to the airspace information page.
5. Press CLR to exit the airspace information page.

Many of the GNC 420's functions are menu driven. Each of the main pages has an options menu, allowing you to custom tailor the corresponding page to your preferences and/or select special features which specifically relate to that page. A *map page options menu* provides additional settings to customize the *map page* and additional features related specifically to the *map page*.

To display the map page options menu, press **MENU** (with the map page displayed).

The following options are available: "Setup Map?", "Measure Dist?", "Data Fields Off?", "Change Fields?" and "Restore Defaults?".

Map Setup

"Setup Map?" allows you to configure the map display to your preferences, including map orientation, land data enable/disable, Jeppesen data enable/disable, automatic zoom, airspace boundaries, and text size. The following table lists the group names and available settings:

Map	Orientation, AutoZoom, Land Data, Aviation Data
Weather	Lightning Mode/Symbol (when applicable)
Traffic	Traffic Mode/Symbol/Label (when applicable)
Line	Active Flight Plan/Direct-To, Lat/Long Grid
Waypoint	User Waypoints, Waypoint Text, Flight Plan Wpts
Airport	Large/Medium/Small Airports and Text
NAVAID	VORs, NDBs, Intersections and Text
Control	Controlled Airspace: Class B, C, D (tower zone)
SUA	Special-Use Airspace: Restricted, MOA, Other
City	Large/Medium/Small Cities and Text
Road	Freeway, National Highway, Local Hwy, Local Road
Other	States/Prov, Rivers/Lakes, Railroads, Wind Vector



Large, Medium and Small classifications are used on the GNC 420 for airports and cities. Large airports are those with a runway longer than 8100 feet. Medium airports include those with a runway longer than 5000 feet or with a control tower. Large cities are those with approximate populations greater than 200,000 and Medium cities are greater than 50,000.

2

NAV PAGES Map Page Options



To change a map setup feature:

1. Rotate the large right knob (⊖) to highlight "Setup Map?" and press **ENT**.
2. To change map orientation, rotate the small right knob (⊕) to select "Map" and press **ENT**. Rotate the large right knob (⊖) to highlight the "Orientation" field and rotate the small right knob (⊕) to select the desired option. Select "North up" to fix the top of the map display to a north heading. Select "Track up" to adjust the top of the map display to your current track heading. Select "DTK up" to fix the top of the map display to your desired course. Press **ENT** to accept the selected option.
3. To enable/disable automatic zoom, rotate the small right knob (⊕) to select "Map" and press **ENT**. Rotate the large right knob (⊖) to highlight the "Auto Zoom" field and rotate the small right knob (⊕) to select "On" or "Off". Press **ENT** to accept the selected option. The automatic zoom feature will automatically adjust the map scale from 2000 nm through each lower scale, stopping at 1.0 nm as you approach your destination waypoint.
4. To enable/disable the wind vector, all background land data or Jeppesen aviation data, rotate the small right knob (⊕) to select the appropriate "Group" name and press **ENT**. Use the large right knob (⊖) to highlight the appropriate field and rotate the small right knob (⊕) to select "On" or "Off". Press **ENT** to accept the selected option.
5. For airports, NAVAIDs, active flight plan waypoints, user-created waypoints, state/provincial boundaries, rivers/lakes and cities: rotate the small right knob (⊕) to select the appropriate "Group" name (per the chart on the previous page) and press **ENT**. Use the large right knob (⊖) to highlight the zoom field for the desired feature and rotate the small right knob (⊕) to select the maximum scale at which the feature should appear on screen. Or select "Off" to never display the selected feature. Press **ENT** to accept the selected option. Next, rotate the large right knob (⊖) to highlight the text field for the desired feature and rotate the small right knob (⊕) to select the desired text size, or select "None" to disable text descriptions. Press **ENT** to accept the selected option.
6. For airspace boundaries, highways, roads, railroad lines, track log data, active flight plan course lines, and lat/long grid lines: rotate the small right knob (⊕) to select the appropriate "Group" name (per the chart on the previous page) and press **ENT**. Use the large right knob (⊖) to highlight the zoom field for the desired feature and rotate the small right knob (⊕) to select the maximum scale at which the feature should appear on screen. Or select "Off" to never display the selected feature. Press **ENT** to accept the selected option.

NAV PAGES Map Page Options

2

Wind Vector

For installations with heading and air data interfaces, the GNC 420 can display a *wind vector* on the map page. The wind vector symbol is located in the lower right corner of the map display. The vector symbol points in the direction the wind is travelling, with wind speed appearing adjacent to the symbol.

To enable/disable the wind vector from the map setup page:

1. Select "Setup Map?" from the map page options. Then rotate the small right knob to select the "other" file tab and press **ENT**.
2. Rotate the large right knob to highlight the "WIND VECTR" option. Then rotate the small right knob to select "ON" or "OFF" and press **ENT**.

Distance Measurements

The "Measure Dist?" option provides a quick, easy method for determining the bearing and distance between any two points on the map display.

To measure bearing and distance between two points:

- 1a. Rotate the large right knob (⊖) to highlight "Measure Dist?" and press **ENT**. An on-screen reference pointer will appear on the map display at your present position.
2. Use the small (⊖) and large (⊖) right knobs to place the reference pointer at the location you wish to measure FROM and press **ENT**.
3. Again, use the small (⊖) and large (⊖) right knobs to place the reference pointer at the location you wish to measure TO. The bearing and distance from the first reference location will appear at the top of the map display.
4. To exit the "Measure Dist?" option, press the small right knob (⊖).

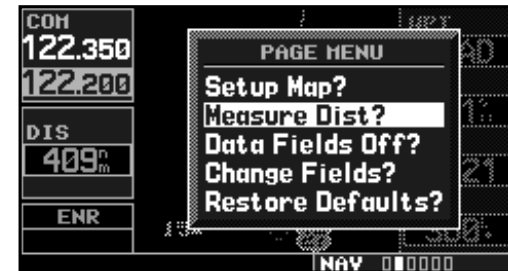

2

NAV PAGES Map Page Options



Selecting Full Screen Map

The “Data Fields Off?” option provides a full-screen map display (shown bottom right), without the four data fields along the right-hand side of the screen. Select this option when you wish to display a larger map area. If this option has been selected and the data fields are off, “Data Fields On?” will appear as an option instead.

To turn the data fields off (or on), rotate the large right knob (⊖) to highlight “Data Fields Off?” (or “Data Fields On?”) and press **ENT**.

Selecting Desired On-Screen Data

“Change Fields?” allows you to choose the data displayed on the four user-selectable data fields along the right-hand side of the *map page*. There are fourteen available data types, including bearing to destination, distance to destination, estimated time of arrival, ground speed, minimum safe altitude and track. See page 161 for descriptions of these (and other) navigation terms.

To change a data field:

1. Rotate the large right knob (⊖) to highlight “Change Fields?” and press **ENT**.
2. Rotate the large right knob (⊖) to highlight the data field you wish to change.
3. Rotate the small right knob (⊕) to select the type of data you want to appear on this field and press **ENT**.
4. Press the small right knob (⊕) to remove the cursor.

NOTE

The on-screen traffic information will occupy two data fields, leaving room to display only two additional data types. Traffic information is only available when the GNC 420 installation includes connection to traffic information sources. See 400 Series Pilot’s Guide Addendum, part number 190-00140-10.

NAV PAGES

NAVCOM Page

2

Restoring Factory Settings

“Restore Defaults?” resets all four user-selectable data fields to their original factory default settings.

To restore the factory default settings, rotate the large right knob (⊖) to highlight “Restore Defaults?” (see bottom left) and press **ENT**.

NAVCOM Page

Departure, Enroute or Arrival Airport

Frequency Type

Assigned Frequency and Usage Information (when applicable)

Third Page in NAV group

The third NAV page is the *NAVCOM (navigation communications) page*. The *NAVCOM page* provides a list of the airport communication and navigation frequencies at your departure, enroute and arrival airports. The *NAVCOM page* makes selection of the frequencies you’ll need along your flight plan quick and convenient. If you do not have an active flight plan with a departure airport, the *NAVCOM page* will display the frequencies for the airport nearest your departure position.

To select a frequency list for a departure, enroute or arrival airport:

1. Press the small right knob (⊖) to activate the cursor.
2. Rotate the large right knob (⊖) to place the cursor on the airport identifier field (top line on the NAVCOM page).
3. Rotate the small right knob (⊖) to select the desired airport and press **ENT**.

PAGE MENU

- Setup Map?
- Measure Dist?
- Data Fields Off?
- Change Fields?
- Restore Defaults?

2

AIRPORT

- 463
- KCLE
- KMSP
- KSEA
- KLPR

3

2

NAV PAGES

NAVCOM Page



scroll bar

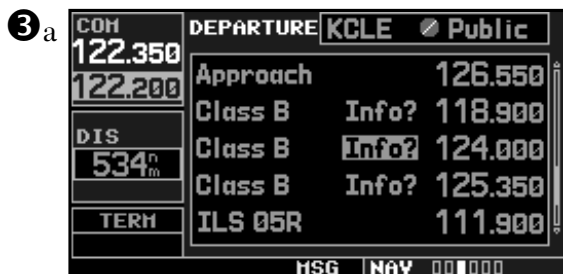

To scroll through the list of frequencies:

1. Activate the cursor, if not already active, by pressing the small right knob (PUSH CURSR).
- 2a. Rotate the large right knob (⊖) to move the cursor through the list of frequencies. If there are more frequencies in the list that can be displayed on the screen, a scroll bar along the right-hand side of the screen will indicate which part of the list is currently being displayed.
- 3a. To place a frequency in the standby field of the COM window, highlight the desired frequency and press ENT. (NAV frequencies are shown for reference only.)

Some listed frequencies may include designations for limited usage, as follows:

- “TX” - transmit only
- “RX” - receive only
- “PT” - part time frequency

If a listed frequency has sector or altitude restrictions, the frequency will be preceded by an “Info?” designation.

To view usage restrictions for a frequency:

1. Rotate the large right knob (⊖) to place the cursor on the “Info?” designation directly in front of the desired frequency.
- 2b. Press ENT to display the restriction information.
- 3b. To return to the NAVCOM page, press ENT.

Position Page

The *position page* (the fourth NAV page) displays your present position (by default, in latitude and longitude) and altitude. The *position page* also displays your current track, ground speed, time and a reference waypoint field. These fields are user-selectable to configure the page to your own preferences and current navigation needs.

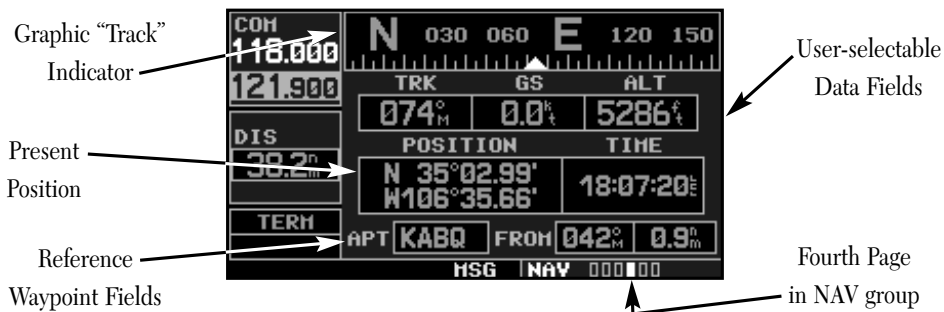

The graphic "track" indicator at the top of the page indicates the direction you're heading, or track, only while you're moving. Directly below are three user-selectable fields, which by default, display track, ground speed and altitude. Barometric pressure (BARO) settings and minimum safe altitude (MSA) can also be displayed on these fields. MSA is the recommended minimum altitude within approximately ten miles of your present position. MSA is calculated from the information contained in the database and generally includes mountains, buildings and other permanent features.

NOTE

Do not rely solely on MSA as an absolute measure of safe altitude. Consult current charts and NOTAMs for your area.

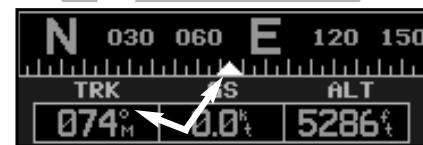

The graphic "track" indicator and the TRK indication directly below it provide the same information. Use the graphic "track" indicator for quick at-a-glance ground track information.



2

NAV PAGES

Position Page

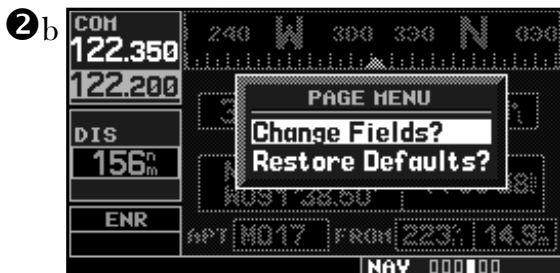

To change the user-selectable data fields:

- 1a. Press **MENU** to display the position page options menu.
- 2a. Rotate the large right knob (⊖) to highlight “Change Fields?” and press **ENT**.
- 3a. Rotate the large right knob (⊖) to highlight the data field you wish to change.
- 4a. Rotate the small right knob (⊖) to display the list of available data items. Continue rotating the small right knob (⊖) to select the desired data item from the list.
5. Press **ENT** to select the desired data item and return to the position page.
6. Press the small right knob (⊖) momentarily to remove the cursor from the page.

The position page also features a reference waypoint field, located at the bottom of the page, to indicate your bearing and distance to/from a selected waypoint. The reference waypoint field can display bearing and distance information for a nearby airport (default), VOR, NDB, intersection or user waypoint.

To change the reference waypoint information:

- 1b. Press **MENU** to display the position page options menu.
- 2b. Rotate the large right knob (⊖) to highlight “Change Fields?” and press **ENT**.
- 3b. Rotate the large right knob (⊖) to highlight the waypoint type field (bottom left corner of the page; default setting will show “APT”).
- 4b. Rotate the small right knob (⊖) to display the list of available waypoint types. Continue rotating the small right knob (⊖) to select the desired data item from the list.
5. Press **ENT** to select the desired type and return to the position page.

{continued}

6. To select between “bearing FROM” or “bearing TO” to the reference waypoint, rotate the small right knob (PUSH CRSR) to select the desired bearing reference and press ENT.
7. Press the small right knob (PUSH CRSR) momentarily to remove the cursor from the page.
8. If “WPT” is selected as the waypoint type, you can designate any airport, NAVAID or user waypoint as a reference waypoint. Press the small right knob (PUSH CRSR), rotate the large right knob (CRSR) to highlight the waypoint identifier field, then use the small (PUSH CRSR) and large (CRSR) right knobs to enter the identifier of the desired waypoint. Press ENT to confirm the selected waypoints. Press the small right knob (PUSH CRSR) to remove the cursor.

NAV PAGES

Position Page

2

Restoring Factory Settings

A “Restore Defaults?” option allows you to reset all data fields to their original factory default settings. This will return the three user-selectable fields at the top of the page AND the reference waypoint fields to default settings.

To restore the factory default settings:

1. Press MENU to display the position page options menu.
2. Rotate the large right knob (CRSR) to highlight “Restore Defaults?” and press ENT.



6



8



2

2

NAV PAGES Satellite Status Page

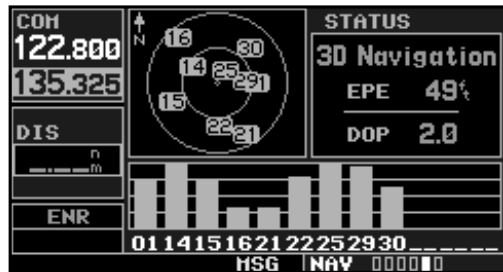
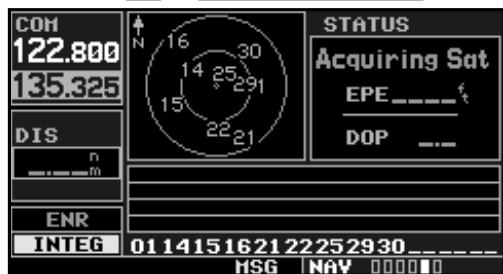

Satellite Status Page

The *satellite status page* (the fifth NAV page) provides a visual reference of GPS receiver functions, including current satellite coverage, GPS receiver status and position accuracy. The *satellite status page* is helpful in troubleshooting weak (or missing) signal levels due to poor satellite coverage or installation problems.

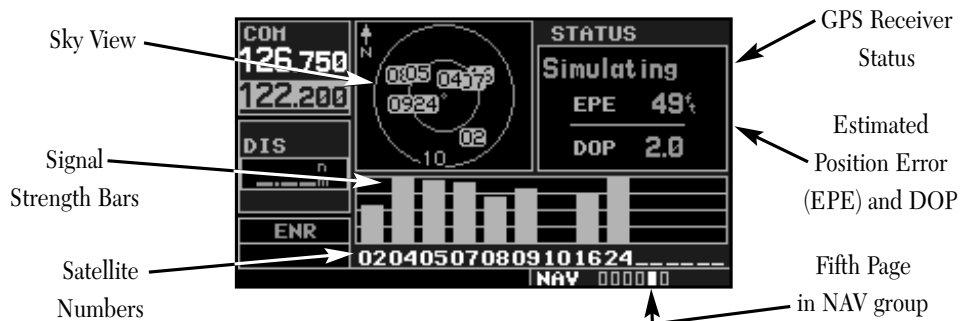

As the GPS receiver locks onto satellites, a signal strength bar will appear for each satellite in view, with the appropriate satellite number (01-32) underneath each bar. The progress of satellite acquisition is shown in three stages:

- No signal strength bars—the receiver is looking for the satellites indicated.
- Hollow signal strength bars—the receiver has found the satellite(s) and is collecting data (see illustration at center left).
- Solid signal strength bars—the receiver has collected the necessary data and the satellite(s) is ready for use (see illustration at bottom left).

The sky view display (at top left corner of the page) shows which satellites are currently in view, and where they are. The outer circle of the sky view represents the horizon (with north at top of the page); the inner circle 45° above the horizon; and the center point directly overhead.

NAV PAGES

Satellite Status Page

2

Each satellite has a 30-second data transmission that must be collected (hollow signal strength bar) before the satellite may be used for navigation (solid signal strength bar). Once the GPS receiver has determined your position, the GNC 420 will indicate your position, track and ground speed on the other navigation pages. The GPS receiver status field (see preceding page) will also display the following messages under the appropriate conditions:

- Searching Sky— The GPS receiver is searching the sky for ANY visible satellites. You will also be informed of this status with a “Searching the Sky” message.
- Acquiring Sat— The GPS receiver is acquiring satellites for navigation. In this mode, the receiver uses satellite orbital data (collected continuously from the satellites) and last known position to determine which satellites should be in view.
- 2D Navigation— The GPS receiver is in 2D navigation mode. Altitude data will be provided by an altitude serializer.
- 3D Navigation— The GPS receiver is in 3D navigation mode and will compute altitude using satellite data.
- Poor Coverg— The GPS receiver cannot acquire sufficient satellites for navigation.
- Rcvr Not Usbl— The GPS receiver is unusable due to incorrect initialization or abnormal satellite conditions. Turn the unit off and on again.
- AutoLocate— The GPS receiver is looking for any available satellite. This process can take up to five minutes to determine a position.

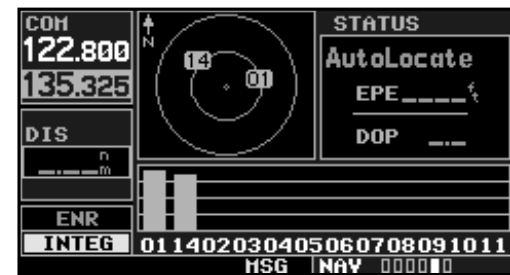

2

NAV PAGES Vertical Navigation (VNAV)



The *satellite status page* also indicates the accuracy of the position fix, using Estimated Position Error (EPE) and Dilution of Precision (DOP) figures. DOP measures satellite geometry quality (i.e., number of satellites received and where they are relative to each other) on a scale from one to ten. The lowest numbers are the best accuracy and the highest numbers are the worst. EPE uses DOP and other factors to calculate a horizontal position error, in feet or meters.

Vertical Navigation Page

The GNC 420's vertical navigation page (the last NAV page) allows you to create a three-dimensional profile which guides you from your present position and altitude to a final (target) altitude at a specified location. This is helpful when you'd like to descend to a certain altitude near an airport or climb to an altitude before reaching a route or direct-to waypoint. Once the profile is defined, message alerts and additional data on the default NAV and map pages will keep you informed of your progress.

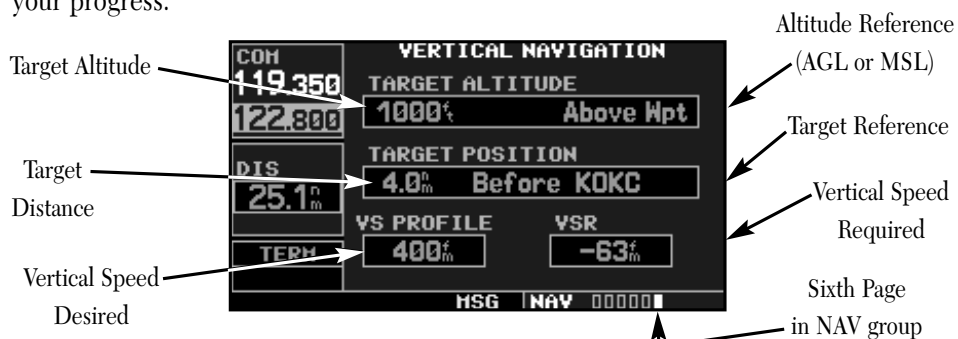

NOTE

To use the vertical navigation features, your ground speed must be greater than 35 knots and you must be navigating to a direct-to destination or using a flight plan.

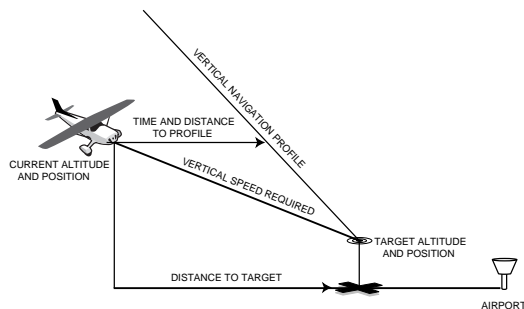

To create a vertical navigation profile:

1. Press the small right knob (PUSH CRSB) to activate the cursor.
2. Rotate the large right knob (CRSB) to highlight the target altitude field.
3. Rotate the small (PUSH CRSB) and large (CRSB) right knobs to select the target altitude and press ENT.
4. Rotate the small right knob (PUSH CRSB) to select "Above Wpt" (AGL) or "MSL", and press ENT. "Above Wpt" will use the altitude of a destination airport as stored in the Jeppesen NavData card. "MSL" lets you set a specific target altitude for any waypoint category: airport, VOR, NDB, intersection or user waypoint.
5. Rotate the small (PUSH CRSB) and large (CRSB) right knobs to select a distance from the target reference waypoint and press ENT. If the target altitude should occur at the target reference waypoint, enter a distance of zero.
6. Rotate the small right knob (PUSH CRSB) to select "Before" or "After", and press ENT. This setting designates whether the offset distance defines a point before you reach the target reference waypoint or after you reach the waypoint.
7. When using a flight plan, the target reference waypoint itself can be specified from the waypoints contained in the flight plan. By default, the last waypoint in the flight plan will be selected. To select a different waypoint, rotate the small right knob (PUSH CRSB) to select the desired waypoint and press ENT.

{continued}

NAV PAGES

Vertical Navigation (VNAV) 2



2

3

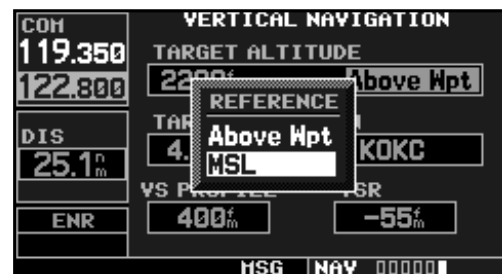

4



5

2

NAV PAGES Vertical Navigation (VNAV)

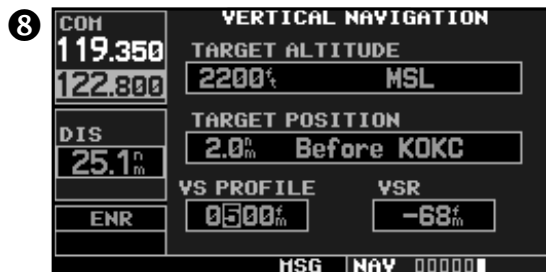

GPS accuracy may be degraded by the U.S. Department of Defense-imposed Selective Availability (SA) program. With “SA” on, GPS altitude may be in error by several hundred meters. Errors of this magnitude may result in fluctuations in the VSR readout on the default NAV page.

8. The default profile utilizes a 400 foot-per-minute descent rate. To change the rate, rotate the large right knob (⊖) to highlight the “VS Profile” field and use the small (⊖) and large (⊖) right knobs to enter a new rate. Press **ENT** when finished.

With the profile set, the vertical speed required (VSR) is displayed on the *vertical navigation page*. Expect the following to occur when using the vertical navigation feature:

- At one minute prior to reaching the initial descent point, a message “Approaching VNAV Profile” occurs. The descent (or climb) angle will also lock to prevent changes in speed from altering the profile.
- If selected, the vertical speed required (VSR) readout on the *default NAV* and *map pages* will show the desired vertical speed to maintain the proper descent (or climb) angle.
- At 500 feet above (or below, for a climb) the target altitude, an “Approaching Target Altitude” message is provided. The VSR readout on the *default NAV* and *map pages* is blanked out, at this point.

Vertical navigation messages can be turned on or off. (By default the messages are off.) Turning the messages off allows you to keep the profile settings you’ve entered previously, without having them generate messages when the feature isn’t needed.

To disable/enable the vertical navigation (VNAV) messages:

1. Press **MENU** to display the vertical navigation page options menu.
2. With “VNAV Messages On?” highlighted, press **ENT**. Or, if the messages are already on and you wish to turn them off, make sure “VNAV Messages Off?” is highlighted and press **ENT**.
3. To restore the original factory settings, with “Restore Defaults?” highlighted, press **ENT**.

Section 3

Direct-To Navigation

The GNC 420's direct-to function provides a quick method of setting a course to a destination waypoint. Once a direct-to is activated, the GNC 420 will establish a point-to-point course line (great circle) from your present position to the selected destination waypoint. Navigation data on the various NAV pages will provide steering guidance until the direct-to is cancelled or replaced by a new destination.

To select a direct-to destination:

- 1a. Press the **BD>** key. The select direct-to waypoint page will appear, with the waypoint identifier field highlighted.
2. Use the small (**CRS**) and large (**ENT**) right knobs to enter the identifier of the desired destination waypoint.
3. Press **ENT** to confirm the selected waypoint, and **ENT** to activate the direct-to function.

If you're navigating to a waypoint and get off course, the direct-to function may also be used to re-center the CDI (HSI) needle and proceed to the same waypoint.

To re-center the CDI (HSI) needle to the same destination waypoint:

- 1b. Press the **BD>** key, followed by **ENT** twice.

NOTE

*If you're navigating an approach with the missed approach point (MAP) as the current destination, re-centering the CDI (HSI) needle with the **BD>** key will cancel the approach.*

DIRECT-TO

Selecting a Destination

3

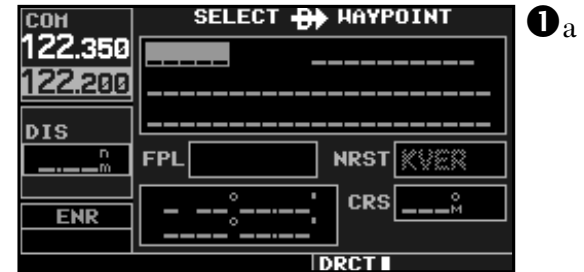

3

DIRECT-TO

Selecting by Facility or City



To select the direct-to destination by facility name (shown above) or city location (shown below), highlight the second or third line on the direct-to waypoint page. Use the small (PUSH OPEN) and large (PUSH OPEN) right knobs to enter the facility name or city. The identifier(s) for any matching entries will appear on the top line of the page.



Selecting a Destination by Facility Name or City

In addition to selecting a destination by identifier, the *select direct-to waypoint page* also allows you to select airports, VORs and NDBs by facility name or city location. If duplicate entries exist for the entered facility name or city, additional entries may be viewed by continuing to rotate the small right knob (PUSH OPEN) during the selection process. (See page 88 for more information on duplicate waypoints.)

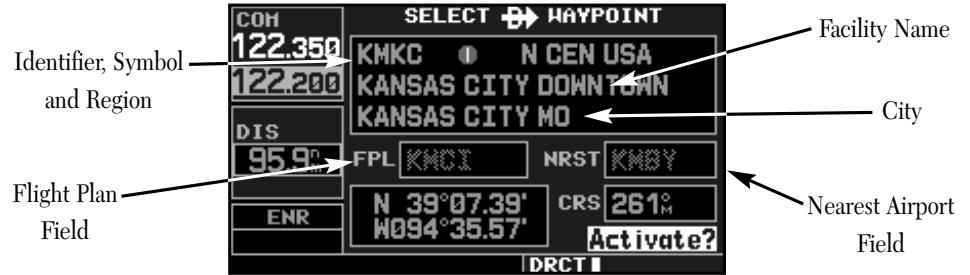

To select a direct-to destination by facility name or city:

1. Press the (B->) key. The select direct-to waypoint page will appear, with the waypoint identifier field highlighted.
2. Rotate the large (PUSH OPEN) right knob to highlight the facility name (second line; see above) or the city (third line; see above) field.
3. Use the small (PUSH OPEN) and large (PUSH OPEN) right knobs to enter the facility name or city location of the desired destination waypoint. As you spell the facility name or city, the GNC 420's Spell'N'Find feature will select the first entry in the database based upon the characters you have entered up to that point.
4. Continue rotating the small right knob (PUSH OPEN) to scroll through any additional database listings for the selected facility name or city. You can also scroll backwards with the small right knob (PUSH OPEN) if you scroll past the desired waypoint.
5. Press (ENT) to confirm the selected waypoint, and (ENT) to activate the direct-to function.

Selecting a Destination from the Active Flight Plan

If you're navigating an active flight plan, any waypoint contained in the flight plan may be selected as a direct-to destination from the *select direct-to waypoint page*. (See section 4, beginning on page 54, for more information on flight plans.)

To select a direct-to destination from the active flight plan:

1. Press the **⇨** key. The select direct-to waypoint page will appear, with the waypoint identifier field highlighted.
- 2a. Rotate the large **⦿** right knob to highlight the flight plan (FPL) field.
- 3a. Rotate the small right knob **⦿** to display a window showing all waypoints in the active flight plan.
4. Continue rotating the small right knob **⦿** to scroll through the list and highlight the desired waypoint.
5. Press **ENT** to confirm the selected waypoint, and **ENT** to activate the direct-to function.

Selecting the Nearest Airport as a Direct-To Destination

The *select direct-to waypoint page* always displays the nearest airports (from your present position) on the NRST field. Navigating directly to a nearby airport is always just a few simple steps away. (Nearby airports may also be selected as direct-to destinations using the steps described on page 113.)

To select a nearby airport as a direct-to destination:

1. Press the **⇨** key. The select direct-to waypoint page will appear, with the waypoint identifier field highlighted.
- 2b. Rotate the large **⦿** right knob to highlight the nearest airport (NRST) field.
- 3b. Rotate the small right knob **⦿** to display a window showing up to nine nearby airports.
4. Continue rotating the small right knob **⦿** to scroll through the list and highlight the desired airport.
5. Press **ENT** to confirm the selected airport, and **ENT** to activate the direct-to function.

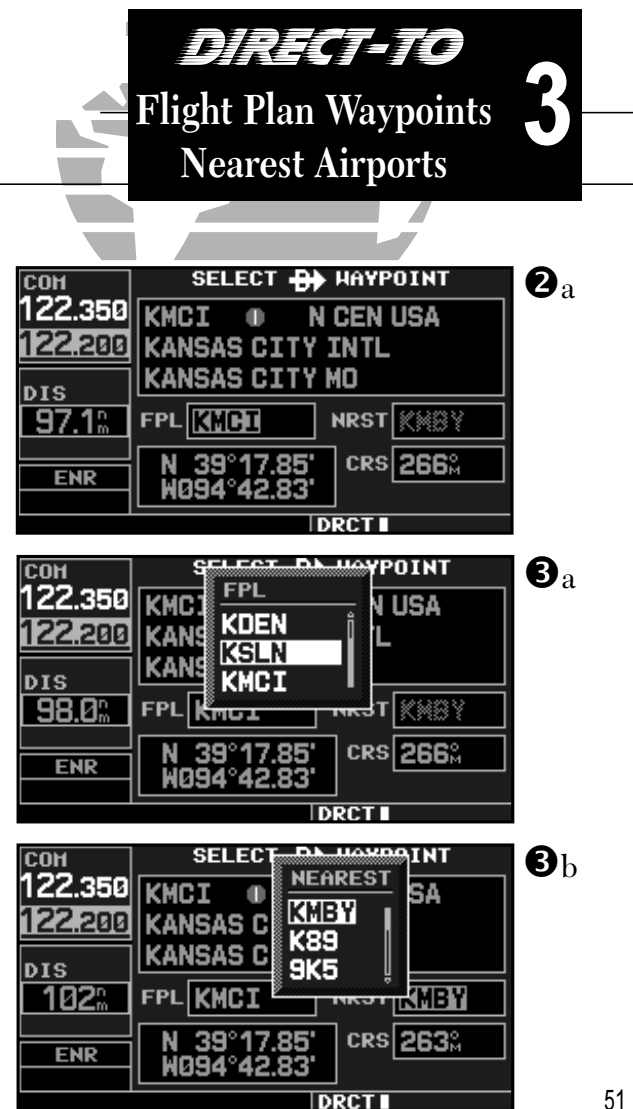

3

DIRECT-TO

Direct-To Shortcuts



Shortcuts

Shortcuts are available when using the **-B->** key, allowing you to bypass the use of the small (**PUSH CRSH**) and large (**ENT**) right knobs to enter the destination waypoint's identifier. A direct-to can be performed from any page displaying a single waypoint identifier (such as the WPT pages for airports and navaids) by simply pressing **-B->** and **ENT**. For pages that display a list of waypoints (e.g., the *nearest airport page*), you must highlight the desired waypoint with the cursor before pressing the **-B->** key.

To select an on-screen waypoint as a direct-to destination:

- 1a. If a single airport, navaid or user waypoint is displayed on-screen: press **-B->**, then press **ENT** twice.
- 2a. If a list of waypoints is displayed on-screen: press the small right knob (**PUSH CRSH**) to activate the cursor, rotate the large right knob (**ENT**) highlight the desired waypoint, then press **-B->** followed by **ENT** twice.

Direct-to destinations may also be selected from the *map page*, by panning to the desired destination location and pressing **-B->** and **ENT** (twice). If no airport, navaid or user waypoint exists at the desired location, a waypoint named "+MAP" will automatically be created at the location of the panning pointer.

To select a direct-to destination from the map page:

- 1b. From the map page, press the small right knob (**PUSH CRSH**) to display a panning pointer.
- 2b. Rotate the small (**PUSH CRSH**) and large (**ENT**) right knobs to place the panning pointer at the desired destination location.
3. If the panning pointer is placed on an existing airport, navaid or user waypoint, the waypoint name will be highlighted. Press **-B->** and **ENT** twice to navigate to the waypoint.
4. If the panning pointer is placed on an open location, press **-B->** and **ENT** twice to create a "MAP" waypoint and navigate to it.

Canceling Direct-To Navigation

Once a direct-to is activated, the GNC 420 will provide navigation guidance to the selected destination until the direct-to is replaced with a new direct-to or flight plan, cancelled, or the unit is turned off.

To cancel a direct-to:

1. Press the **-B->** key to display the select direct-to waypoint page.
- 2a. Press **MENU** to display the direct-to options menu.
- 3a. With "Cancel Direct-To NAV?" highlighted, press **ENT**. If a flight plan is still active, the GNC 420 will resume navigating the flight plan along the closest leg.

Manually Defining the Direct-To Course

Whenever you perform a direct-to, the GNC 420 will set a direct great circle course to your selected destination. You can also manually define the course to your destination, using the "CRS" course field on the *select direct-to waypoint page*.

To manually define a direct-to course:

1. Press the **-B->** key.
- 2b. Use the small **(PUSH ORBIT)** and large **(ENT)** right knobs to select the destination waypoint.
- 3b. Press **ENT** to confirm the selected waypoint, then rotate the large right knob **(ENT)** to highlight the course ("CRS") field.
4. Rotate the small **(PUSH ORBIT)** and large **(ENT)** right knobs to select the desired course and press **ENT**.
5. Press **ENT** again to begin navigation using the selected destination and course.
6. To reselect a direct course from present position (or select a new manually-defined course), simply press **-B->**, followed by **ENT** twice.

DIRECT TO Cancelling & Manual Course

3



2 a

3 a



3 b



4

4

FLIGHT PLANS

Creating Flight Plans



Section 4 Flight Plans

The GNC 420 lets you create up to 20 different flight plans, with up to 31 waypoints in each flight plan. The flight plan page group consists of two pages, accessed by pressing the **FPL** key. The flight plan pages allow you to create, edit and copy flight plans.



Active Flight Plan



Flight Plan Catalog

Flight Plan Catalog

The *flight plan catalog* allows you to create, edit, activate, delete and copy flight plans. Flight plans numbered from 1 through 19 are used to save flight plans for future use. “Flight plan 0” is reserved exclusively for the flight plan currently in use for navigation. Any time you activate a flight plan, a copy of the flight plan is automatically transferred to “flight plan 0” and overwrites any previously active flight plan.

To create a new flight plan:

1. Press **FPL** and rotate the small right knob (PUSH CRSR) to display the flight plan catalog.
2. Press **MENU** to display the flight plan catalog options.
3. Rotate the large right knob (CRSR) to highlight “Create New Flight Plan?” and press **ENT**.
4. A blank flight plan page will appear for the first empty storage location. Use the small (PUSH CRSR) and large (CRSR) right knobs to enter the identifier of the departure waypoint and press **ENT**.
5. Repeat step #3 above to enter the identifier for each additional flight plan waypoint.
6. Once all waypoints have been entered, press the small right knob (PUSH CRSR) to return to the flight plan catalog.

FLIGHT PLANS

Editing Flight Plans

4

Flight Plan Editing

To add a waypoint to an existing flight plan:

1. Press **FPL** and rotate the small right knob (PUSH CRSR) to display the flight plan catalog.
2. Press the small right knob (PUSH CRSR) to activate the cursor.
3. Rotate the large right knob (CRSR) to highlight the desired flight plan and press **ENT**.
- 4a. Rotate the large right knob (CRSR) to select the point where you wish to add the new waypoint. If an existing waypoint is highlighted, the new waypoint will be placed directly in front of this waypoint.
- 5a. Use the small (PUSH CRSR) and large (CRSR) right knobs to enter the identifier of the new waypoint and press **ENT**.
6. Once all changes have been made, press the small right knob (PUSH CRSR) to return to the flight plan catalog.

To delete a waypoint from an existing flight plan:

1. Press **FPL** and rotate the small right knob (PUSH CRSR) to display the flight plan catalog.
2. Press the small right knob (PUSH CRSR) to activate the cursor.
3. Rotate the large right knob (CRSR) to highlight the desired flight plan and press **ENT**.
- 4b. Rotate the large right knob (CRSR) to select the waypoint you wish to delete and press **CLR** to display a "remove waypoint" confirmation window.
- 5b. With "Yes" highlighted, press **ENT** to remove the waypoint.
6. Once all changes have been made, press the small right knob (PUSH CRSR) to return to the flight plan catalog.

A one-line user comment may be added to any flight plan, which will be displayed on the flight plan catalog, next to the flight plan's number. By default, as the flight plan is being created, the comment will show the first and last waypoints in the flight plan.



4 a

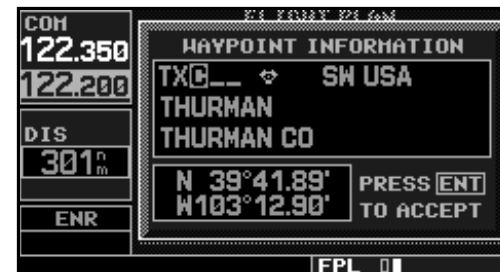

5 a



5 a

4

FLIGHT PLANS

Activating/Inverting Flight Plans



To change the comment line for an existing flight plan:

1. From the flight plan catalog, press the small right knob (PUSH CRSR) to activate the cursor.
2. Rotate the large right knob (CRS) to highlight the desired flight plan and press ENT.
- 3a. Rotate the large right knob (CRS) to select the comment line at the top of the screen.
4. Use the small (PUSH CRSR) and large (CRS) right knobs to enter the new comment. Press ENT when finished.
5. Once all changes have been made, press the small right knob (PUSH CRSR) to return to the flight plan catalog.

Activating Flight Plans

Once a flight plan is defined through the *flight plan catalog* (using the steps previously outlined), it may be activated for navigation. Activating the flight plan places it into “flight plan 0” and overwrites any previous information at that location.

To activate an existing flight plan:

1. From the flight plan catalog, press the small right knob (PUSH CRSR) to activate the cursor.
2. Press MENU to display the flight plan catalog options.
- 3b. Rotate the large right knob (CRS) to highlight “Activate Flight Plan?” and press ENT.

Inverting Flight Plans

After travelling along a flight plan, you may wish to reverse the route for navigation guidance back to your original departure point.

To activate an existing flight plan in reverse order:

1. Follow the steps above to “activate an existing flight plan”.
2. With the active flight plan page displayed, press MENU to display the active flight plan options window.
- 3c. Rotate the large right knob to highlight “Invert Flight Plan?” and press ENT. The original flight plan will remain intact in its flight plan catalog storage location.

Copying Flight Plans

If you want to save a flight plan currently located in “flight plan 0”, be sure to copy it to an open catalog location (1-19) before the flight plan is cancelled, overwritten or erased.

To copy a flight plan to another flight plan catalog location:

- 1a. From the active flight plan page, press **MENU** to display the active flight plan options window.
- 2a. From the flight plan catalog, press the small right knob (**PUSH CRSR**) to activate the cursor, rotate the large right knob (**CRSR**) to highlight the flight plan you wish to copy, then press **MENU** to display the flight plan catalog options.
- 3a. Rotate the large right knob (**CRSR**) to highlight “Copy Flight Plan?” and press **ENT**.
4. By default, the next empty catalog location will be offered. To select a different location, rotate the large right knob (**CRSR**) to select the flight plan number, use the small (**PUSH CRSR**) and large (**CRSR**) right knobs to enter a different number and press **ENT**.
5. With “Yes?” highlighted, press **ENT** to copy the flight plan.

Deleting Flight Plans

Once you are finished with a flight plan, it can easily be deleted from the flight plan catalog or the active flight plan page.

To delete a flight plan:

- 1b. From the active flight plan page, press **MENU** to display the active flight plan options window.
- 2b. From the flight plan catalog, press the small right knob (**PUSH CRSR**) to activate the cursor, rotate the large right knob (**CRSR**) to highlight the flight plan you wish to copy, then press **MENU** to display the flight plan catalog options.
- 3b. Rotate the large right knob (**CRSR**) to highlight “Delete Flight Plan?” and press **ENT**.
4. With “Yes?” highlighted, press **ENT** to delete the flight plan.



4

FLIGHT PLANS

Flight Plan Catalog Options



Flight Plan Catalog Options

The following options (some covered on the preceding pages) are available for the *flight plan catalog*:

Activate Flight Plan? allows you to select the flight plan for navigation guidance, as described on page 56.

Invert & Activate FPL? allows you to reverse the highlighted flight plan and select it for navigation guidance, as described on page 56.

Create New Flight Plan? allows you to create a new flight plan, as described on page 54.

Crossfill? allows you to transfer a direct-to-destination, the active flight plan, any stored flight plan or user waypoints to a second 400-Series or 500-Series GARMIN unit. Some crossfill operations can be done automatically. If both units are set to “auto”, a change in the direct-to-destination or active flight plan on one unit will also be seen on the other.

To crossfill flight plans between two GPS units:

1. Select the “Crossfill?” option from the flight plan catalog options and press **ENT**.
2. Rotate the large right knob (⊖) to select the “Method” field.
3. Rotate the small right knob (⊕) to select “Auto” or “Manual” and press **ENT**. “Auto” will automatically transfer the active flight plan or direct-to selection to another 400- or 500-series GARMIN unit, without user intervention.
4. If “Manual” is selected. Rotate the large right knob (⊖) to select the “Transfer” field, then, rotate the small right knob (⊕) to select the type of information to transfer between units (active flight plan, flight plan, all user waypoints, or a single user way point). When “Flight Plan” or “User Waypoint” is selected, a second field will appear to the immediate right of the “Transfer” field. Use the small (⊕) and large (⊖) right knobs to enter the number of the flight plan or the name of the user waypoint you wish to transfer.
5. The “Cross-Side” field allows you to designate the sending and receiving units in a crossfill operation. Rotate the large right knob (⊖) and select the “Cross-Side” field, then rotate the small right knob (⊕) to select “To” or “From”. Press **ENT** to confirm the selection.
6. Rotate the large right knob (⊖) to highlight “Initiate Transfer?” and press **ENT**.

Copy Flight Plan? allows you to copy the selected flight plan to a new flight plan location, as described on page 57. The copy function is useful for duplicating an existing flight plan before making changes.

Delete Flight Plan? allows you to remove the selected flight plan from memory, as described on page 57. Deleting a flight plan does not delete the individual waypoints contained in the flight plan from the database or user waypoint memory.

Delete All Flight Plans? allows you to remove all flight plans from memory at one time.

To delete all flight plans:

- 1a. Select the “Delete All Flight Plans?” option from the flight plan catalog options and press **ENT**.
2. A confirmation window will appear. With “Yes?” highlighted, press **ENT**.

Sort List By Number?/Sort List by Comment? allows you to select between a flight plan catalog sorted numerically by the flight plan number or sorted alphanumerically based upon the comment assigned to each flight plan. When either option is selected, the other option will appear on the flight plan catalog options window.

To sort the catalog listing by number or comment:

- 1b. Select the “Sort List By Number?” or “Sort List By Comment?” option (whichever is currently displayed) from the flight plan catalog options and press **ENT**.

Active Flight Plan

The active flight plan page provides information and editing functions for “flight plan 0”—the flight plan currently in use for navigation. Once you have activated a direct-to or flight plan, the active flight plan page will show each waypoint for the flight plan (or a single waypoint for a direct-to), along with the desired track (DTK) and distance (DIS) for each leg. The data fields for DTK and DIS are user-selectable and may be changed to display cumulative distance (CUM) to each waypoint, estimated time of arrival (ETA), estimated time enroute (ETE) or enroute safe altitude (ESA).



4

FLIGHT PLANS

Active Flight Plan Options

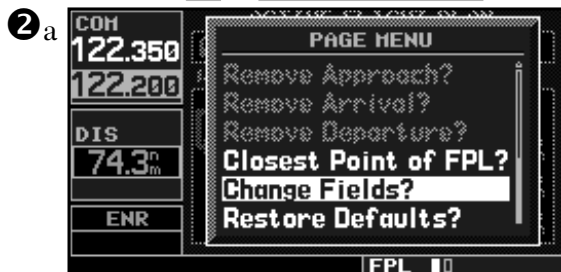

To change a data field on the active flight plan page:

1. With the active flight plan page displayed, press **MENU** to display the active flight plan page options window.
- 2a. Rotate the large right knob (⊖) to highlight "Change Fields?" and press **ENT**.
3. Rotate the large right knob (⊖) to highlight the field you wish to change.
4. Rotate the small right knob (⊕) to select the desired data item and press **ENT**.
5. Press the small right knob (⊕) to remove the cursor.

To restore factory default settings for data fields on the active flight plan page:

1. With the active flight plan page displayed, press **MENU** to display the active flight plan page options window.
- 2b. Rotate the large right knob (⊖) to highlight "Restore Defaults?" and press **ENT**.

Active Flight Plan Options

The following options (some covered on the preceding pages) are available for the *flight plan catalog*:

Activate Leg? activates/reactivates the flight plan and selects the highlighted leg as the "active leg" (the leg which will currently be used for navigation guidance).

To activate a flight plan along a specific leg:

1. Press the small right knob (⊕) to activate the cursor and rotate the large right knob (⊖) to highlight the desired destination waypoint.
- 2c. Select the "Activate Leg?" option from the active flight plan page options and press **ENT**.
3. A confirmation window will appear. With "Activate?" highlighted, press **ENT**.

Crossfill? allows you to transfer the active flight plan between two 400 series units in a dual unit installation. See page 58 for additional information on this feature.

Copy Flight Plan? copies the active flight plan to a flight plan catalog location, as described on page 57. The copy function is useful for duplicating the active flight plan before making changes.

Invert Flight Plan? reverses the active flight plan. See description of “Invert & Activate FPL” option on page 56.

Delete Flight Plan? allows you to remove all waypoints from the selected flight plan, as described on page 57. Deleting a flight plan does not delete the waypoints contained in the flight plan from the database or user waypoint memory.

Select Approach? allows you to select a published instrument approach for the destination airport, or replace the current approach with a new selection. (In many cases, you’ll find it more convenient to select approaches using the **PROC** key—as described on page 66.)

To select an approach for a direct-to or flight plan destination airport:

1. Select the “Select Approach?” option from the active flight plan page options and press **ENT**.
2. A window will appear listing the available approaches for your destination airport. Rotate the small right knob (**PUSH CRSEL**) to highlight the desired approach and press **ENT**.
3. A second window will appear listing available transitions for the approach. Rotate the small right knob (**PUSH CRSEL**) to highlight the desired transition waypoint and press **ENT**. (The “Vectors” option assumes you will receive vectors to the final course segment of the approach and will provide navigation guidance to intercept this final course.)
4. Rotate the large right knob (**CRSEL**) to highlight “Load?” or “Activate?” and press **ENT**. “Load?” will add the approach to the flight plan without immediately using the approach for navigation guidance. This allows you to continue navigating the original flight plan until cleared for the approach—but, keeps the approach available for quick activation when needed.
5. For precision approaches, a reminder window will appear indicating that GPS guidance on such approaches is strictly for monitoring only. To confirm this reminder, highlight “Yes?” and press **ENT**.

FLIGHT PLANS

Active Flight Plan Options

4

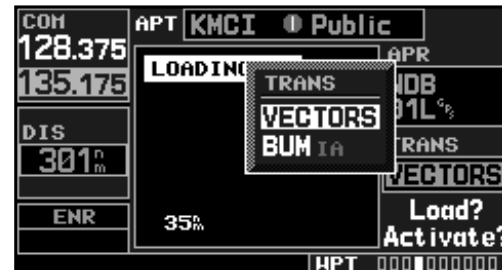
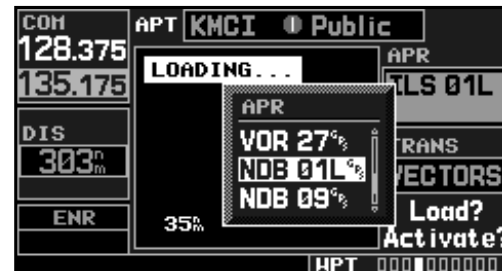

4

FLIGHT PLANS

Active Flight Plan Options



Select Arrival? allows you to select a published standard terminal arrival route (STAR) for the destination airport, or replace the current arrival with a new selection. (See page 66 for information on selecting arrivals using the **PROC** key.)

To select an arrival for a direct-to or flight plan destination airport:

- 1a. Select the “Select Arrival?” option from the active flight plan page options and press **ENT**.
- 2a. A window will appear listing the available arrivals for your destination airport. Rotate the small right knob (**PUSH CRB**) to select the desired arrival and press **ENT**.
- 3a. A second window will appear listing available transitions for the arrival. Rotate the small right knob (**PUSH CRB**) to highlight the desired transition waypoint and press **ENT**.
4. With “Load?” highlighted, press **ENT**.

Select Departure? allows you to select a published standard instrument departure (SID) for the departure airport, or replace the current departure with a new selection. When using a direct-to, the GNC 420 will use the nearest airport as a reference when displaying available departures. See page 66 for information on selecting departures using the **PROC** key.

To select a departure for the departure airport:

- 1b. Select the “Select Departure?” option from the active flight plan page options and press **ENT**.
- 2b. A window will appear listing the available departures for your departure airport. Rotate the small right knob (**PUSH CRB**) to select the desired departure and press **ENT**.
- 3b. A second window will appear listing available transitions for the departure. Rotate the small right knob (**PUSH CRB**) to highlight the desired transition waypoint and press **ENT**.
4. With “Load?” highlighted, press **ENT**.

Remove Approach? deletes the currently selected approach from the active flight plan.

Remove Arrival? deletes the current STAR from the active flight plan.

Remove Departure? deletes the current SID from the active flight plan.

To remove an approach, arrival or departure from the active flight plan:

- 1a. Select the “Remove Approach?”, “Remove Arrival?” or “Remove Departure?” option from the active flight plan page options and press **ENT**.
2. A confirmation window will appear listing the procedure you are about to remove. With “Yes?” highlighted, press **ENT**.

Closest Point of FPL? calculates the bearing and closest distance that a flight plan will pass from a reference waypoint. May also be used to create a new user waypoint along the flight plan at the location closest to the reference waypoint.

To determine the closest point, along the active flight plan, to a selected waypoint:

- 1b. Select the “Closest Point of FPL?” option from the active flight plan page options and press **ENT**.
2. A window will appear with the reference waypoint field highlighted. Use the small (⊖) and large (⊕) right knobs to enter the identifier of the reference waypoint and press **ENT**.
3. A confirmation window will appear for the selected reference waypoint. Press **ENT** to accept the waypoint.
4. The GNC 420 will display the bearing (BRG) and distance (DIST) to the closest point along the flight plan, from the selected reference waypoint. To create a user waypoint at this location and add it to the flight plan, highlight “Load?” and press **ENT**. The name for the new user waypoint will be derived from the identifier of the reference waypoint.

Change Fields? allows you to select the desired data items to display on the active flight plan page, as described on page 60.

Restore Defaults? returns the data items to factory defaults. See page 60.

FLIGHT PLANS

Active Flight Plan Options

4

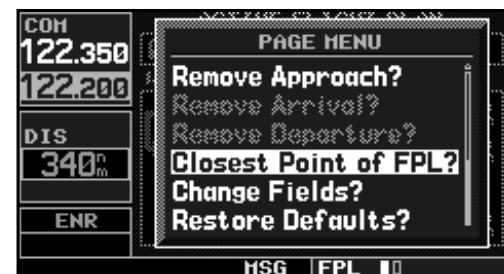

4

FLIGHT PLANS

Active Flight Plan Editing



Shortcuts

A number of shortcuts are available to save time when using the active flight plan page. These shortcuts speed the process of removing approaches, departures and arrivals, and aid in selecting a specific flight plan leg for navigation guidance.

On the preceding page, options to remove approaches, departures and arrivals were introduced. This process may also be completed using the **CLR** key, as described below and illustrated at left.

To remove an approach, departure or arrival using the **CLR** key:

1. With the active flight plan page displayed, press the small right knob (**PUSH CRB**) to activate the cursor.
- 2a. Rotate the large right knob (**CRB**) to highlight the title for the approach, departure or arrival you wish to delete. Titles will appear in light blue directly above the procedure's waypoints.
- 3a. Press **CLR** to display a confirmation window.
4. With "Yes?" highlighted, press **ENT** to remove the selected procedure.

This same process may also be used to remove individual waypoints from the active flight plan.

To remove a waypoint using the **CLR** key:

1. With the active flight plan page displayed, press the small right knob (**PUSH CRB**) to activate the cursor.
- 2b. Rotate the large right knob (**CRB**) to highlight the identifier for the waypoint you wish to delete. Identifiers will appear in green text.
- 3b. Press **CLR** to display a confirmation window.
4. With "Yes?" highlighted, press **ENT** to remove the selected procedure.

On page 58 the “Activate Leg?” option is discussed, which allows you to specify which leg of the flight plan will currently be used for navigation guidance. A shortcut also exists for this operation, using the **-B->** key.

To activate a specific leg of the active flight plan:

1. Press the small right knob (PUSH CRSR) to activate the cursor and rotate the large right knob (CRS) to highlight the desired destination waypoint.
- 2a. Press **-B->** twice to display an “Activate Leg” confirmation window.
3. With “Activate?” highlighted, press **ENT**.

When using instrument procedures, this feature can be used not only to activate a specific point-to-point leg, but to also activate the procedure turn portion of an approach, follow a DME arc or activate a holding pattern.

Any approach, departure or arrival can be reviewed on the appropriate airport page in the Waypoint page group. See page 86.

To review a procedure while viewing a flight plan page:

1. With the active flight plan page displayed, press the small right knob (PUSH CRSR) to activate the cursor.
- 2b. Rotate the large right knob (CRS) to highlight the procedure header and press **ENT** to select the WPT page group. “WPT” will appear in the lower right corner of the screen.
3. Rotate the small right knob (PUSH CRSR) to select the desired WPT page.

FLIGHT PLANS

Active Flight Plan Leg Selection

4



1



2 a



2 b

5

PROCEDURES

Approaches, Departures & Arrivals

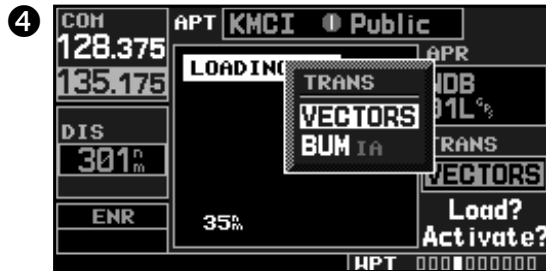
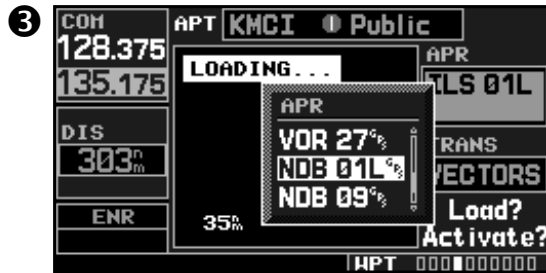
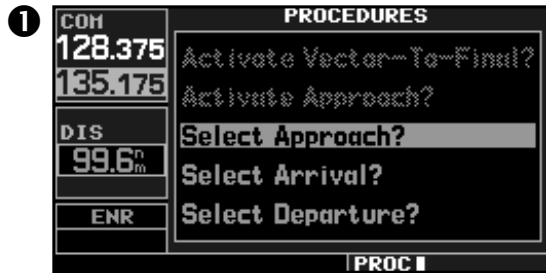

Section 5

Approaches, Departures & Arrivals

The GNC 420 allows you to fly non-precision and precision approaches to airports with published instrument approach procedures. All available approaches are stored on your Jeppesen NavData® card, and are automatically updated when you replace the card with a new one. Subscription information for NavData cards is included in your GNC 420 package.

The *procedures page* (shown at top left) is displayed by pressing the **PROC** key. The *procedures page* provides direct access to approaches, departures and arrivals—based upon the active flight plan or direct-to destination. In either case, the departure and destination airports must have published procedures associated with them.

To select an approach, departure or arrival:

1. Press the **PROC** key to display the procedures page.
2. Rotate the large right knob (⊖) to highlight “Select Approach?”, “Select Departure?” or “Select Arrival?” and press **ENT**.
3. A window will appear listing the available procedures. Rotate the large right knob (⊖) to highlight the desired procedure and press **ENT**. (When a direct-to destination is selected, departures are offered for the nearest airport.)
4. A second window will appear listing the available transitions. Rotate the large right knob (⊖) to highlight the desired transition waypoint and press **ENT**. (The approach “Vectors” option assumes you will receive vectors to the final course segment of the approach and will provide navigation guidance relative to the final approach course.)
5. Rotate the large right knob (⊖) to highlight “Load?” or “Activate?” (approaches only) and press **ENT**. (“Load?” will add the procedure to the flight plan without immediately using it for navigation guidance. This allows you to continue navigating the original flight plan, but keeps the procedure available on the active flight plan page for quick activation when needed.)
6. For precision approaches and some non-precision approaches, a reminder window will appear indicating that GPS guidance on such approaches is strictly for monitoring only—use an external VOR/ILS receiver and CDI (or HSI) for primary navigation. To confirm this reminder, highlight “Yes?” and press **ENT**.



Not all approaches in the database are approved for GPS use. As you select an approach, a “GPS” designation to the right of the procedure name indicates the procedure can be flown using the GPS receiver. Some procedures will not have this designation, meaning the GPS receiver may be used for supplemental navigation guidance only. ILS approaches, for example, must be flown by tuning the VLOC receiver to the proper frequency and coupling the VLOC receiver to the external CDI (or HSI).

Once an approach is selected, it may be activated for navigation from the *procedures page*. Activating the approach overrides the “enroute” portion of the active flight plan, proceeding directly to the “approach” portion (for a full approach, directly to the initial approach fix). Activating the approach also initiates automatic CDI scaling transition as the approach progresses.

To activate an approach:

- 1a. With the procedures page displayed, rotate the large right knob (⊖) to highlight “Activate Approach?” and press **ENT**.
- 2a. A confirmation window will appear. With “Yes?” highlighted, press **ENT**.

Another procedures page option allows you to activate the final course segment of the approach. This option assumes you will receive vectors to the final approach fix (FAF) and guides you to intercept the final course, before reaching the FAF.

To activate the approach, with vectors to final:

- 1b. With the procedures page displayed, rotate the large right knob (⊖) to highlight “Activate Vector-To-Final?” and press **ENT**.
- 2b. A confirmation window will appear. With “Yes?” highlighted, press **ENT**.

In many cases, it may be easiest to “Load” the full approach while still some distance away, enroute to the destination airport. Later, if vectored to final, use the steps above to select “Activate Vector-To-Final”—which makes the inbound course to the FAF waypoint active. Otherwise, activate the full approach using the “Activate Approach?” option.

PROCEDURES

Activating Approaches

5

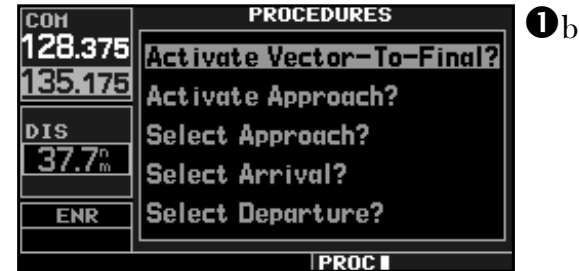
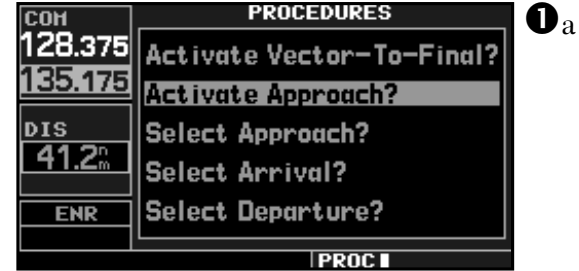

5

PROCEDURES

Basic Approach Operations

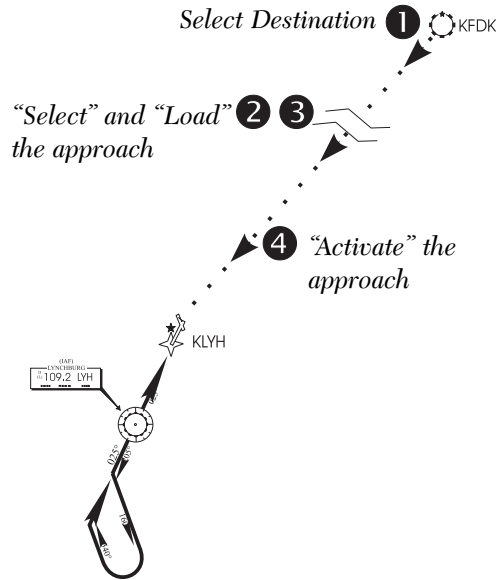

Basic Approach Operations

The GNC 420 provides non-precision approach guidance using its built-in GPS receiver. The GPS receiver can also be used as a supplemental aid for precision approaches, but external localizer and glideslope receivers **MUST** be used for primary approach course guidance.

Approaches designed specifically for GPS are often very simple and don't require overflying a VOR or NDB. Currently, many non-precision approaches have "GPS overlays" to let you fly an existing procedure (VOR, VOR/DME, NDB, RNAV, etc.) more accurately using GPS. To date, there are over 2,400 GPS-only approaches and over 2,900 GPS overlay approaches.

Many overlay approaches are complex (in comparison to GPS-only approaches). The GNC 420 displays and guides you through each leg of the approach—automatically sequencing through each of these legs, up to the missed approach point (MAP). Approaches may be flown "as published" with the full transition—using any published feeder route or initial approach fix (IAF)—or may be flown with a vectors-to-final transition.

Approach operations on the GNC 420 will typically begin with the same basic steps:

1. Select the destination airport using the **[B->]** key, or as the last waypoint in the active flight plan.
2. Choose the "Select Approach?" option from the procedures page (see page 66) or from the active flight plan options (see page 59).
3. "Load" the approach (often while enroute) in anticipation of its future use. This places the approach in the active flight plan, but retains course guidance in the enroute section until the approach is "activated".
4. "Activate" the full approach or vectors-to-final, as appropriate. In some scenarios, you may find it more convenient to immediately activate the approach and skip the "Load" process outlined above in step #3. The GNC 420 provides both options.

PROCEDURES

Procedure Turn Approach Example

5

Approaches with Procedure Turns

The procedure turn portion of an approach is stored as one of the legs of the approach. For this reason, the GNC 420 requires no special operations from the pilot—other than flying the procedure turn itself—beyond what is required for any other type of approach.

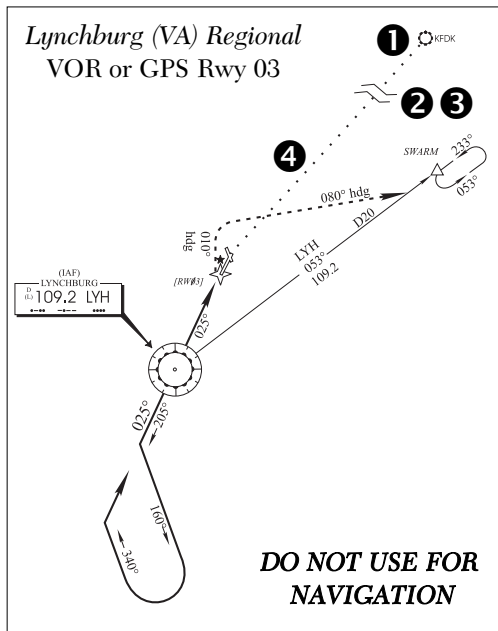

This example uses the VOR Runway 03 approach for Lynchburg (Virginia) Regional Airport, KLYH, and assumes a departure from Frederick (Maryland) Municipal Airport, KFDK. The steps required to set up and fly the approach are detailed below:

1. Prior to departing KFDK, the destination (KLYH) is selected using the **B** key or by creating a flight plan terminating at Lynchburg Regional.
2. While enroute to KLYH, some 40-50 nautical miles away, you select the ATIS frequency to monitor airport conditions and runway usage. This is accomplished by selecting the NAV-COM page (see page 39) and selecting the ATIS frequency from the list. This places the frequency on standby. Use the **FREQ** key to make the ATIS frequency active.
3. From ATIS you learn that runway 03 is in use and plan your approach accordingly. Press the **PROC** key and select the "VOR 03" approach using the steps outlined on page 66. From the transitions window, select the LYH VOR (the IAF). Also, select "Load?" to load (but not activate) the approach.
4. Once you are cleared for the approach, press the **PROC** key, select "Activate Approach?" and press **ENT**.



PROCEDURES

5

Procedure Turn Approach Example



Flying the Procedure Turn

1. Within 30 nautical miles of the destination airport, the GNC 420 will switch from "enroute" mode to "terminal" mode (as indicated in the lower left corner of the screen). The switch to terminal mode is accompanied by a gradual Course Deviation Indicator (CDI) scale transition from 5.0 to 1.0 nautical miles, full scale deflection. (See example, top left.)
2. Several miles prior to reaching the IAF (LYH), you may wish to review the approach sequence. Press the **FPL** key to display the active flight plan page. Press the small right knob (PUSH CRSR) and rotate the large right knob (C) to review each segment of the approach. When finished, press **FPL** again to return to the previous page.
3. As you approach the IAF (LYH), a waypoint alert ("NEXT DTK 205°") will appear in the lower right corner of the screen. As the distance (DIS) to the IAF approaches zero, the alert is replaced by a turn advisory ("TURN TO 205°"). Dial the outbound course of 205° into the CDI (or HSI) using the OBS knob and initiate a standard rate turn to this course heading.
4. Fly the outbound course, keeping the CDI needle centered.
5. Once you have flown approximately one minute past the FAF (LYH), the alert message "START PROC TURN" will appear in the lower right corner of the screen. You may initiate the procedure turn at any time after receiving this alert message.

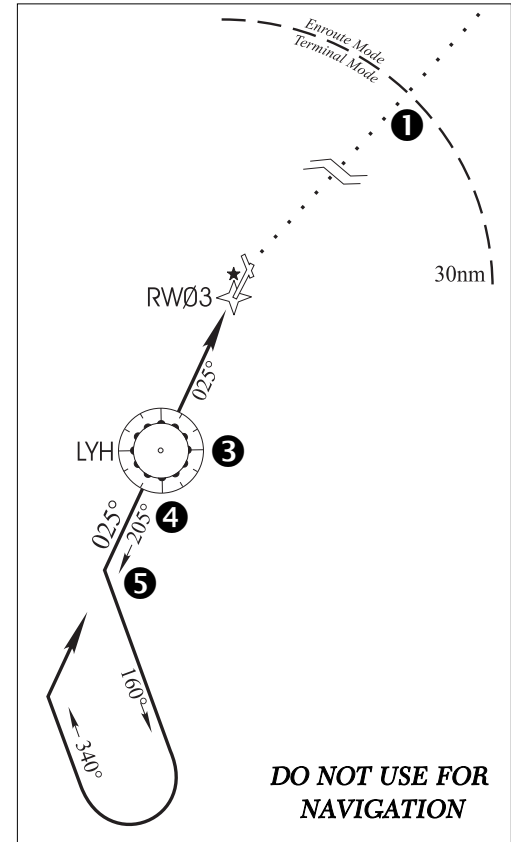

PROCEDURES

Procedure Turn Approach Example

5

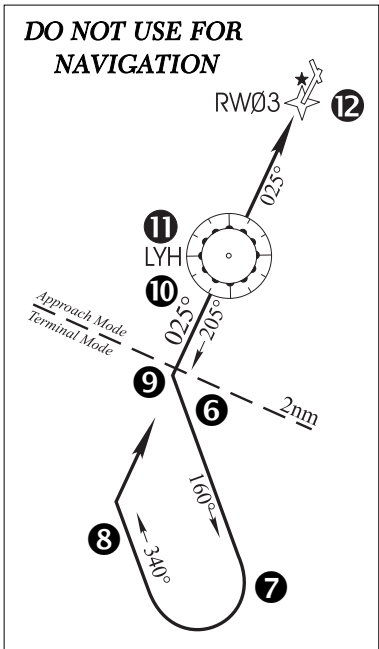

- Turn left to a heading of 160° to initiate the procedure turn. Course guidance is provided relative to the outbound leg from the FAF. No guidance through the procedure turn itself is given. (The procedure turn is displayed on the map page and indicated as the active leg on the default NAV and active flight plan pages.) The CDI needle will start moving to the right.
- After approximately one minute, make a 180° right turn to a heading of 340° to intercept the inbound course. The GNC 420 will sequence to the inbound leg to the FAF, the CDI needle will swing to the opposite side to provide proper sensing along the final course segment and "NEXT DTK 025°" will appear in the lower right corner of the screen.
- As the CDI needle starts to center, make a right turn to 025°—the final approach course.
- Within 2.0 nautical miles of the FAF (LYH), the GNC 420 will switch from terminal mode to "approach" mode. CDI scaling will be tightened from 1.0 to 0.3 nautical mile, full scale deflection.
- As you approach the FAF, a waypoint alert in the lower right corner ("NEXT DTK 025°") will appear. Make any course adjustments necessary for the final course segment (FAF to MAP).

11. As you cross the FAF, the destination sequences to the MAP ("RW03", the runway threshold). With the needle centered, fly toward the MAP, observing the altitude minimums dictated by the approach plate.

NOTE When viewing the map page, note that the final course segment is displayed in magenta (the active leg of the flight plan always appears in magenta) and a dashed line extends the course beyond the MAP. The dashed line is provided for situational awareness only and should NOT be used for navigation. Follow the published missed approach procedures.

12. As you cross the MAP, "SUSP" will appear above the **OBS** key, indicating that automatic sequencing of approach waypoints will be suspended at the MAP. A "from" indication will be displayed on the CDI and default NAV page, but course guidance along the final approach course will continue. If a missed approach is required, use the **OBS** key to initiate the missed approach sequence, as outlined on the following page.



7
9

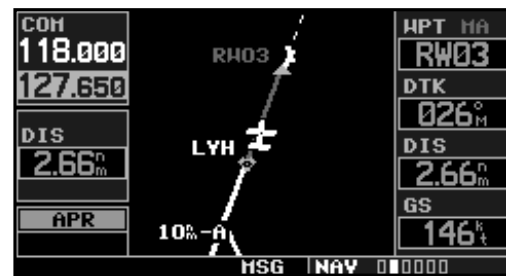

11
NOTE



12

5

PROCEDURES

Missed Approach Example

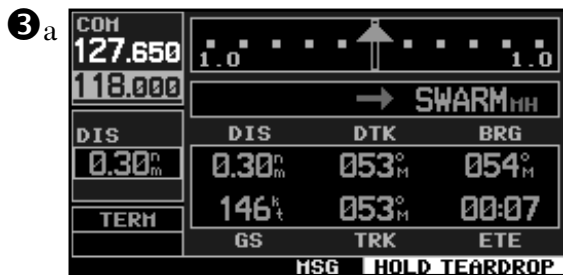

Flying the Missed Approach

After you pass the MAP, if the runway isn't in sight you must execute a missed approach. The GNC 420 continues to give guidance along an extension of the final course segment (FAF to MAP) until you manually initiate the missed approach procedure (as mentioned previously in reference to the "SUSP" advisory). The **OBS** key is used to initiate the missed approach, as follows:

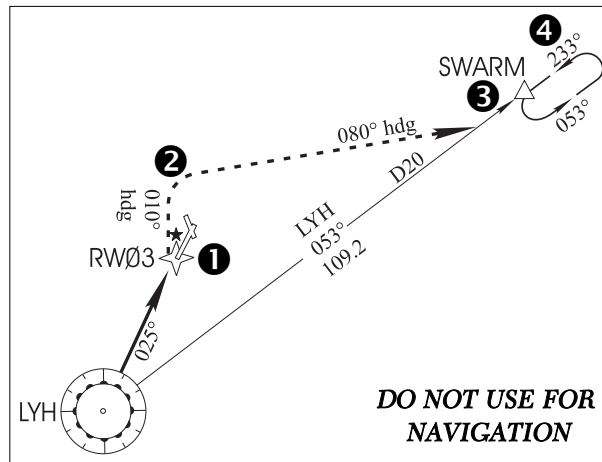

1. Press the **OBS** key. The missed approach holding point (MAHP; in this case "SWARM" intersection) is automatically offered as the destination waypoint.

NOTE

In some cases, an additional hold waypoint is added to the missed approach sequence. This additional waypoint is used as an aid in establishing the holding pattern—especially where the MAP and MAHP are the same waypoint.

2. Follow the missed approach procedures, as published on your approach plate, for proper climb and heading instructions. The GNC 420 will guide you to the holding pattern, along the 053° radial from LYH VOR.

{continued}

- 3a. An alert message in the lower right hand corner of the screen will recommend entry procedures for the holding pattern (i.e., “HOLD DIRECT”, “HOLD PARALLEL”, or “HOLD TEARDROP”). As you fly the holding pattern, a timer appears on the default NAV page. The timer automatically resets on the outbound side of the hold when you are abeam the hold waypoint. The timer again resets as you turn inbound (within approximately 30° of the inbound course). This allows you to use standard timing (typically one minute) to fly the inbound and outbound legs of the hold.
- 4a. The GNC 420 will provide course guidance only on the inbound side of the holding pattern. When leaving the holding pattern to re-fly the approach (or another approach) press the **PROC** key to “Select Approach?” or “Activate Approach?” as previously described. (Or, use the **B->** key to select another destination.)

Flying an Approach with a Hold

Starting where the previous example left off, we’ll assume weather conditions resulted in a missed approach at Lynchburg Regional. Now, you’ve decided to divert to Farmville Regional (KFVX) instead.

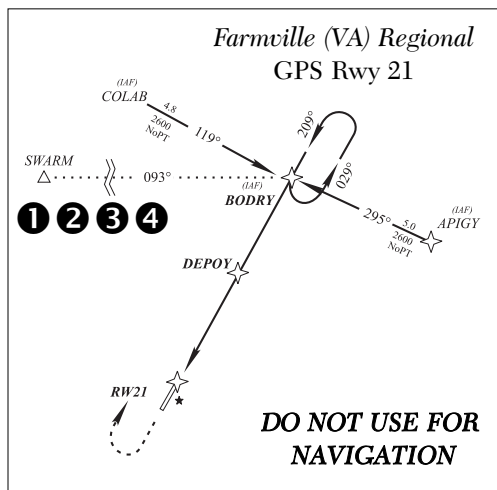

1. Press **B->**.
 2. Use the small **RIGHT** and large **ENT** right knobs to enter the destination airport’s identifier (KFVX).
- 3b. Press **ENT** twice.
- This time, you select the GPS runway 21 approach into Farmville Regional. The GPS runway 21 approach begins with a holding pattern at the IAF, BODRY intersection.
- 4b. Press **PROC** and select the “GPS 21” approach. (See page 66 for additional instructions.)

{continued}

PROCEDURES

Approach with Hold Example

5



2

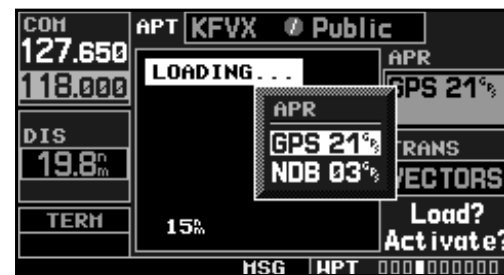

4 b

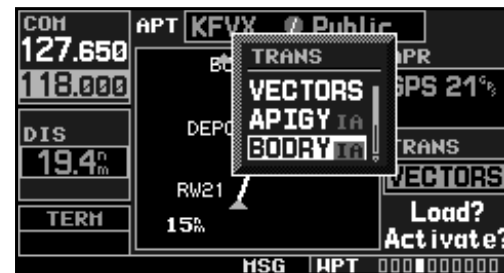

5

5

PROCEDURES

Approach with Hold Example

6

ACTIVE FLIGHT PLAN			
COH 127.650	00	KFDK / KFBX	
118.000		WAYPOINT	DTK DIS
Approach GPS 21			
DIS 23.4 _m	→BODRY	IA 087° _M	23.4 _m
	hold	209° _M	01:00
TERH	DEPOY	FA 209° _M	5.0 _m
HSG FPL			

8

COH 132.725	1.0		
135.400	BODRY IA		
DIS 0.36 _m	DIS	DTK	BRG
	0.36 _m	093° _M	093° _M
TERH	143 _t	093° _M	00:08
	GS	TRK	ETE
HSG HOLD TEARDROP			

9

10

COH 135.400	1.0		
132.725	BODRY		
DIS 0.50 _m	DIS	DTK	BRG
	0.50 _m	209° _M	354° _M
TERH	143 _t	211° _M	--:--
	GS	TRK	ETE
SUSP HSG NAV 00000			

5. From the transitions window, select BODRY intersection as the IAF. Also, select “Activate?” to load and activate the approach.

6. Once you activate the approach, the active flight plan page will appear. You may review the approach sequence by pressing the small right knob (FPL) and rotating the large right knob (FPL). Press FPL to return to the navigation pages.

7. As in the last example, within 30 nautical miles of the airport, the GNC 420 will switch from enroute mode to terminal mode, and the CDI scale will transition from 5.0 to 1.0 nautical miles, full scale deflection.

8. Just prior to crossing BODRY intersection, an alert—“HOLD TEARDROP”—will appear in the lower right corner of the screen to suggest the proper holding pattern entry. (“HOLD DIRECT” or “HOLD PARALLEL” may be offered on other similar approaches.)

9. As mentioned in the missed approach example, the default NAV page will display a timer during the holding pattern. Use this timer to fly the one minute outbound portion of the holding pattern. (The holding pattern is displayed on the map page and indicated as the active leg on the default NAV and active flight plan pages.)

10. When crossing the IAF, “SUSP” will appear above the OBS key, indicating that automatic sequencing of approach waypoints is temporarily suspended. As you make the turn inbound, “SUSP” will be cancelled and the GNC 420 will return to automatic sequencing.

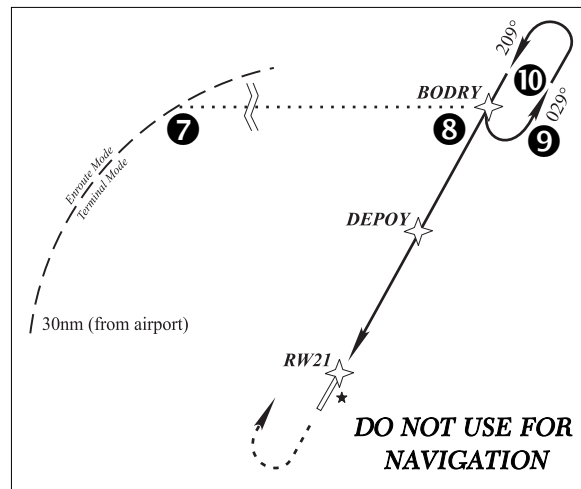

NOTE

If you need to lose extra altitude or speed by going around the holding pattern again, press **OBS** to manually suspend waypoint sequencing BEFORE crossing the holding waypoint the second time. If you've already passed this waypoint, re-activate the holding pattern using the steps described on page 65.

PROCEDURES

Approach with Hold Example

5

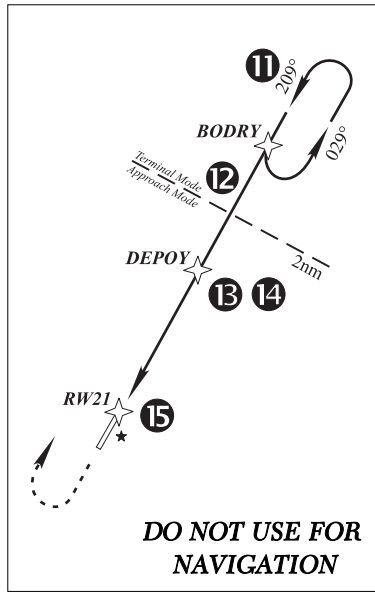

11. Also as you approach BODRY intersection, a waypoint alert ("NEXT DTK 209°") will appear in the lower right corner of the screen.
12. At 2.0 nautical miles from the FAF (DEPOY intersection), the GNC 420 will switch from terminal mode to approach mode. CDI scaling will be tightened from 1.0 to 0.3 nautical mile, full scale deflection.
13. As you approach the FAF, a waypoint alert in the lower right corner ("NEXT DTK 209°") will appear. Make any course adjustments necessary for the final course segment (FAF to MAP).
14. As you cross the FAF, the destination sequences to the MAP ("RW21", the runway threshold). With the needle centered, fly toward the MAP, observing the altitude minimums dictated by the approach plate. (When viewing the map page, you'll note that the final course segment is displayed in magenta—the active leg of the flight plan always appears in magenta—and a dashed line extends the course beyond the MAP. Do NOT follow this extended course. Instead, follow published missed approach procedures.)
15. As you cross the MAP, "SUSP" will appear above the **OBS** key, indicating that automatic sequencing of approach waypoints will be suspended at the MAP. A "from" indication will be displayed on the CDI and default NAV page, but course guidance along the final approach course will continue. If a missed approach is required, use the **OBS** key to initiate the missed approach sequence, as outlined on page 72.

COM	135.400	1.0	↑	1.0	11
	132.725	01:00 BODRY			
DIS	0.27 ⁿ _m	DIS	DTK	BRG	
		0.27 ⁿ _m	209° _M	214° _M	
TERH	135 ^k _t	GS	TRK	ETE	
				00:06	
HSG NEXT DTK 209°					

COM	135.400	0.4	↑	0.4	13
	132.725	BODRY → DEPOY _{FA}			
DIS	0.29 ⁿ _m	DIS	DTK	BRG	
		0.29 ⁿ _m	209° _M	210° _M	
APR	135 ^k _t	GS	TRK	ETE	
				00:07	
HSG NEXT DTK 209°					

COM	135.400	0.3	↓	0.3	15
	132.725	DEPOY _{FA} → RW21 _{HA}			
DIS	0.09 ⁿ _m	DIS	DTK	BRG	
		0.09 ⁿ _m	209° _M	028° _M	
APR	127 ^k _t	GS	TRK	ETE	
				--:--	
SUSP HSG NAV 000000					

5

PROCEDURES

DME Arc Approach Example

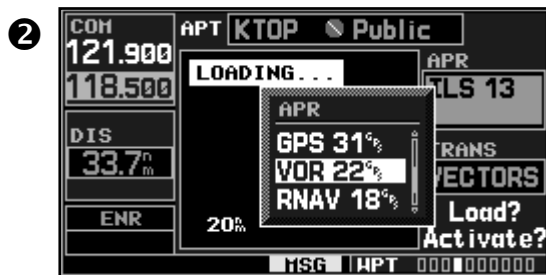

Flying a DME Arc Approach

The GPS overlay for a DME arc approach uses additional Jeppesen-provided waypoints to define the arc. These waypoints are indicated by “D” as the first letter in the waypoint name. This is followed by three numbers which indicate the radial the waypoint lies on. The last letter indicates the radius of the arc.

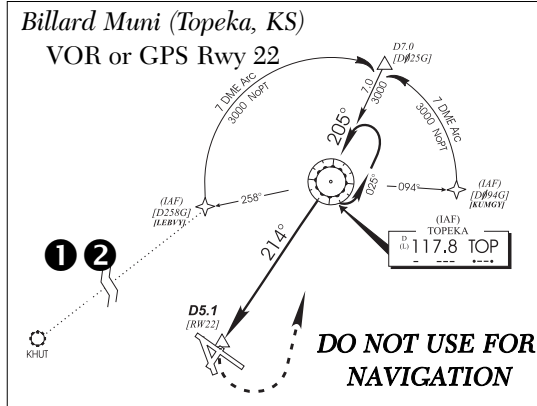

NOTE As this manual was being written, the letter/number DME arc names were being replaced with standard five-letter intersection names. You may encounter either naming convention for an approach you select.

When you are cleared for a DME arc approach, you may do either of the following to intercept the arc:

- Follow a specified radial inbound to intercept the IAF
- Follow ATC vectors which allow you to intercept the arc at any point along the arc.

This example is based upon a flight from Hutchinson (Kansas) Municipal (KHUT) to Billard Municipal (KTOP) in Topeka, Kansas. The VOR/DME runway 22 approach will be selected, along with “D258G” as the IAF

1. Select Billard Muni (KTOP) as your destination, via the **→** key or as the last waypoint in a flight plan.

PROCEDURES

DME Arc Approach Example

5

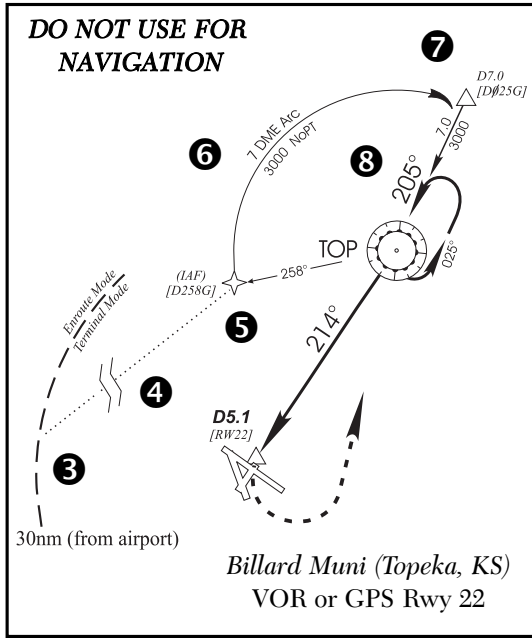

2. Press the **PROC** key and select the "VOR 22" approach using the steps outlined on page 66. From the transitions window, select "D258G" as the IAF. Also, select "Load?" (or "Activate?", if already cleared for the approach).
3. Within 30 nautical miles of KTOP, the GNC 420 will switch from enroute mode to terminal mode and the CDI scale will transition from 5.0 to 1.0 nautical miles, full scale deflection.
4. If you haven't already activated the approach (in step #2 above), be sure to do so when cleared for the approach. See page 69, step #4 for a description of this operation.
5. As you approach the IAF (D258G), a waypoint alert ("NEXT DTK 352°") will appear in the lower right corner of the screen. As the distance (DIS) to the IAF approaches zero, the alert is replaced by a turn advisory ("TURN TO 352°").

6. Follow the arc, keeping the CDI needle centered. When using an autopilot, the course select on the CDI (or HSI) must be periodically updated with the desired track (DTK) to ensure proper tracking through the arc. Whenever the course select setting and desired track differ by more than 10°, a "Set course to ### °" message will appear on the message page.
7. The next point in the approach is an intermediate fix, labeled "D025G". As you approach this intermediate fix, a waypoint alert ("NEXT DTK 205°") will appear in the lower right corner of the screen. As the distance to this fix approaches zero, the alert is replaced by a turn advisory ("TURN TO 205°"). Dial this course into the CDI (or HSI) using the OBS knob and initiate a standard rate turn to this course heading.
8. At 2.0 nautical miles from the FAF (FF21; a Jeppesen-provided waypoint), the GNC 420 will switch from terminal mode to approach mode. CDI scaling will be tightened from 1.0 to 0.3 nautical mile, full scale deflection.

(continued)



PROCEDURES

Vectors-To-Final Approach Example

5

Vectors to Final

Let's take a second look at the "VOR 22" approach into Billard Municipal. Instead of following the DME arc, ATC tells you to expect vectors onto the final approach course. There are several ways to select "vectors to final" with the GNC 420. The first two options below will normally require the least workload to accomplish:

- When the approach is first selected, choose "VECTORS" from the transitions window.
- Load a full approach—including the IAF from the transitions window—as described on page 66. When cleared, press **PROC** and select "Activate Vectors-To-Final?". (See page 67.)
- Load the full approach as described on page 66. Use the **-B->** key (by pressing it twice) from the active flight plan page to select the desired leg of the approach. (See page 65.)

To select "VECTORS" from the transitions window:

- 1a. Select Billard Municipal (KTOP) as your destination, using the **-B->** key, or as the last waypoint in a flight plan.
- 2a. Press the **PROC** key and select the "VOR 22" approach using the steps outlined on page 66.
- 3a. From the transitions window, select "VECTORS".
- 4a. Select "Load?" (or "Activate?", if already cleared for the approach).

To activate vectors-to-final from the procedures page:

- 1b. Select Billard Municipal (KTOP) as your destination, using the **-B->** key or as the last waypoint in a flight plan.
- 2b. Press the **PROC** key and select the "VOR 22" approach using the steps outlined on page 66.
- 3b. From the transitions window, select "D258G" as the IAF. Also, select "Load?".
- 4b. When cleared, press the **PROC** key and select "Activate Vector-To-Final?".

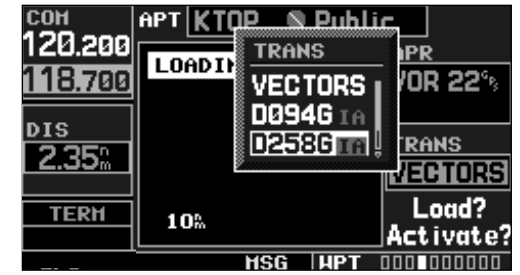
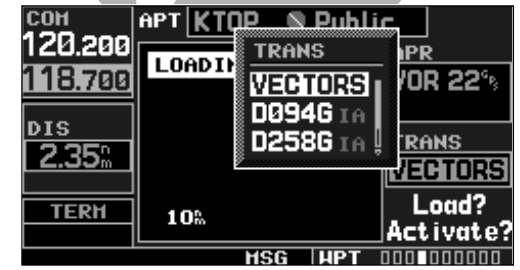

PROCEDURES

5

Vectors-To-Final Approach Example



Flying the Vectors Approach

With “vectors to final” selected, the CDI needle will remain off center until you’re established on the final approach course. With the approach activated, the *map page* will display an extension of the final approach course in magenta (remember, magenta is used to depict the active leg of the flight plan) and “VTF” will appear as part of the active leg on the *default NAV page* (as a reminder that the approach was activated with vectors-to-final). In this example, we’ll assume ATC vectors result in a rectangular course to intercept final, as follows:

1. Within 30 nautical miles of KTOP, the GNC 420 will switch from enroute mode to terminal mode and the CDI scale will transition from 5.0 to 1.0 nautical miles, full scale deflection.
2. If you haven’t already done so, activate the approach (with vectors-to-final). This allows the GNC 420 to guide you to the final approach course. (See page 79.)
3. ATC instructs you to turn left to a heading of 025°. This places you parallel to the final approach course in the opposite direction. CDI needle deflection is to the left.
4. ATC instructs you to turn right to a heading of 115°.
5. ATC instructs you to turn right to a heading of 175° to intercept the final approach course. As you converge with the final approach course the needle moves toward the center. (In the illustration at left, the needle has not yet returned to the on-screen CDI, since your current position is still 1.7 nm right of the final approach course.)

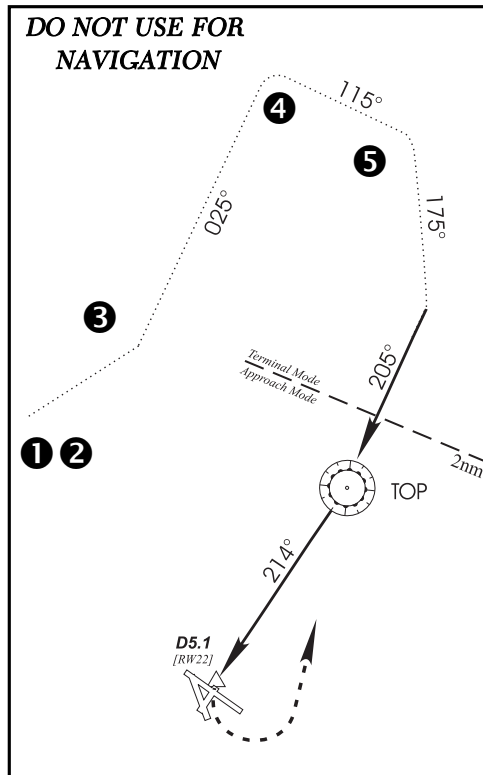

(continued)

PROCEDURES

Vectors-To-Final Approach Example

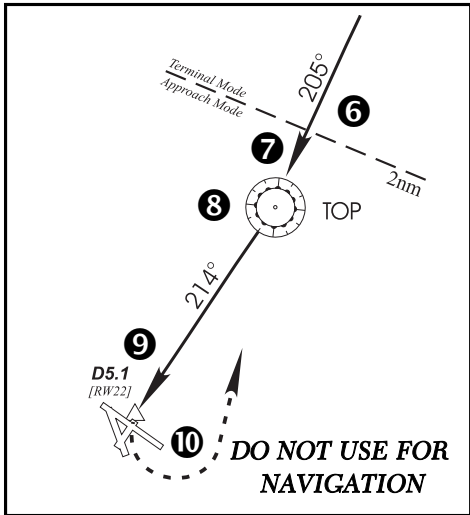

- As the CDI needle centers, make any remaining course corrections to establish yourself on the final approach course. At 2.0 nautical miles from the FAF (TOP VOR), the GNC 420 will switch from terminal mode to approach mode. CDI scaling will be tightened from 1.0 to 0.3 nautical mile, full scale deflection.
- As you approach the FAF, a waypoint alert in the lower right corner ("NEXT DTK 214°") will appear. Make any course adjustments necessary for the final course segment (FAF to MAP).
- As you cross the FAF, the destination sequences to the MAP ("RW22"). With the needle centered, fly toward the MAP, observing the altitude minimums dictated by the approach plate.

9. As you cross the MAP, "SUSP" will appear above the **OBS** key, indicating that automatic sequencing of approach waypoints will be suspended at the MAP. A "from" indication will be displayed on the CDI and default NAV page, but course guidance along the final approach course will continue. Do NOT follow this extended course. Follow published missed approach procedures using the **OBS** key to initiate the missed approach sequence, as outlined on page 72.

6

COM	120.200	0.8	▲	0.8
	120.800		VTf	TOP FA
DIS		DIS	DTK	BRG
		1.25 ⁿ	205°	199°
		135 ^k	192°	00:33
APR		GS	TRK	ETE
HSG NAV 000000				

7

COM	120.200	0.4	▲	0.4
	120.800		VTf	TOP FA
DIS		DIS	DTK	BRG
		0.37 ⁿ	205°	203°
		135 ^k	202°	00:10
APR		GS	TRK	ETE
HSG NEXT DTK 214°				

9

COM	120.800	0.3	▼	0.3
	120.200		TOP FA →	RW22 HA
DIS		DIS	DTK	BRG
		0.06 ⁿ	214°	031°
		124 ^k	214°	00:02
APR		GS	TRK	ETE
SUSP HSG NAV 000000				

5

PROCEDURES

Course From Fix Approach Examples

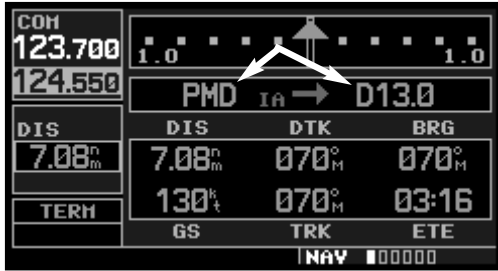

Course From Fix Flight Plan Legs

Certain approach, departure, and arrival procedures in the Jeppesen database contain *course from fix* flight plan legs. The GNC 420 is able to load these legs into the flight plan along with the rest of the procedure data, and to provide navigation along these legs.

There are three different types of course from fix legs:

TYPE 1: Course from fix to distance, or Course from fix to DME distance

Course from fix to distance legs will appear in the flight plan like normal waypoints, but the destination name will always begin with a "D", followed by a distance in tenths of nautical miles from the waypoint fix. This example uses the **VOR/DME RWY 25** approach into Palmdale, California (KPMD) and includes a teardrop course reversal.

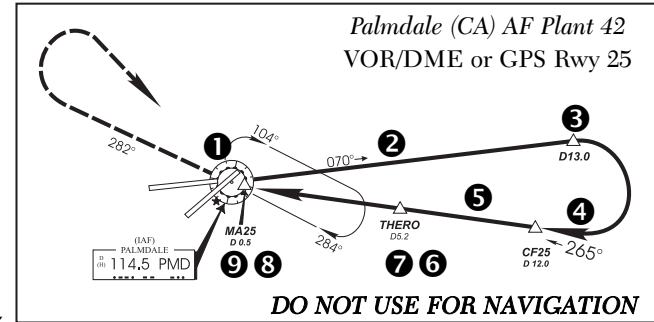

- As you reach the initial approach fix (PMD), a waypoint alert ("NEXT DTK 070°") will appear in the lower right corner of the screen. As the distance to the IAF approaches zero, the alert is replaced by a turn advisory ("TURN TO 070°"). Dial the outbound course into the CDI (or HSI) using the OBS knob and initiate a standard rate turn to this course heading.
- Fly the outbound course, keeping the CDI needle centered. You are now on the 'course from fix to distance' leg, as shown on the active flight plan and default NAV pages. Note the magenta line in the bottom figure, which represents the currently active leg of the approach. The distance (DIS) displayed on the above screens is TO the "D13.0" point. The flight plan will automatically sequence to the next leg upon reaching "D13.0".
- At 13.0 nm from the FAF, a waypoint alert ("NEXT DTK 265°") will appear in the lower right corner of the screen. Make a standard rate turn to the right to intercept the final approach course and watch for the CDI needle to begin to center.

(continued)

4. As you approach the intermediate fix (CF25), a waypoint alert (“NEXT DTK 265°”) will appear. Make any necessary course adjustments.
5. Within 2.0 nautical miles of the FAF (THERO), the GNC 420 will switch from terminal mode to approach mode. (“APR” will appear in the lower left corner of the screen—replacing “TERM”.) CDI scaling will be tightened from 1.0 to 0.3 nautical mile, full scale deflection.
6. As you approach the FAF, “NEXT DTK 265°” will appear in the lower right corner of the screen.
7. As you cross the FAF, the destination sequences to the MAP (MA25). With the CDI needle centered, fly toward the MAP, observing the altitude minimums dictated by the approach plate.
8. As you approach the MAP, a waypoint alert (“APPRCHING WPT”) will appear in the lower right corner of the screen.
9. As you cross the MAP, “SUSP” will appear above the **OBS** key, indicating that automatic sequencing of approach waypoints is suspended at the MAP. If a missed approach is required, use the **OBS** key to initiate the missed approach sequence, as outlined below.

TYPE 2: Course from fix to altitude

Course from fix to altitude legs will show the specific target altitude on the active flight plan and default NAV pages. The missed approach sequence for the Palmdale VOR/DME RWY 25 approach includes a *course from fix to altitude* leg. In this instance, the leg corresponds to the initial phase of the missed approach, which reads “Climb to 5000’ outbound via PMD VOR R-282”.

1. After crossing the MAP, press the **OBS** key. The missed approach sequence is automatically offered, starting with the course from fix to altitude leg. The “NEXT DTK 282°” alert appears in the lower right corner of the screen. Follow the missed approach procedures, as published on your approach plate, for proper climb and heading instructions.
- 2b. Note that within a few seconds of pressing **OBS** to release suspend mode and start the approach sequence, “SUSP” re-appears above the **OBS** key as the GNC 420 returns to suspend mode. This is normal when flying a course from fix to altitude leg and indicates that automatic leg sequencing is suspended.

PROCEDURES

Course From Fix Approach Examples

5

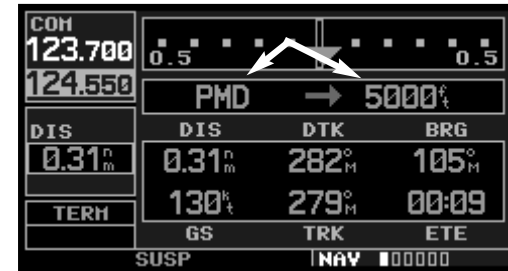

(continued)

5

PROCEDURES

Course From Fix Approach Examples

3



5

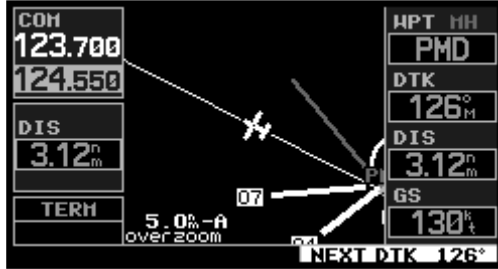

3. Fly the outbound course keeping the CDI needle centered. The map page will depict the flight path extending indefinitely from PMD VOR. The distance (DIS) on the default NAV, map and active flight plan pages will increase—and indicates the distance back to PMD VOR.

4. Upon reaching the desired altitude (5000'), press **OBS** to return to automatic leg sequencing. Confirm that "SUSP" no longer appears directly above the **OBS** key.

5. An alert ("NEXT DTK 126°") will appear guiding you to the inbound course. The actual desired track (DTK) will depend on your ground speed and distance from PMD VOR. Intercept and fly the inbound course, keeping the CDI needle centered.

6. As you approach PMD VOR (the missed approach holding point), an alert message in the lower right hand corner of the screen will recommend the holding pattern entry procedure ("HOLD PARALLEL"). As you fly the holding pattern, a timer appears on the default NAV page. The timer automatically resets on each outbound and inbound portion of the holding pattern.

7. Note that the GNC 420 again displays "SUSP" above the **OBS** key. Automatic waypoint sequencing is suspended at the missed approach holding point. A waypoint alert ("APPROCHING WPT") appears in the lower right corner of the screen each time you approach PMD VOR in the holding pattern.

8. When leaving the holding pattern, press the **PROC** key to reactivate the approach or select a different approach, or press **B>** to select another destination.

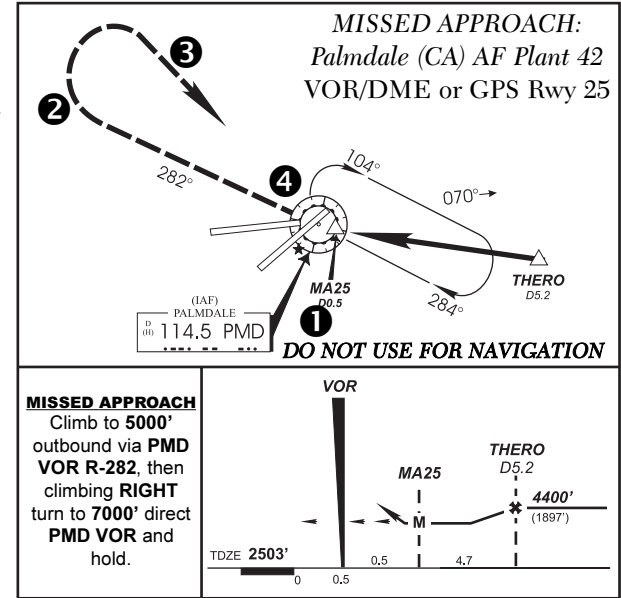

6

WPT PAGES WPT Page Group

Please note that your GNC 420 uses ICAO identifiers for all airports. All U.S. airport identifiers which contain only letters use the prefix 'K'. For example, Los Angeles International is KLAX under the ICAO standard. Other airports, such as Otten Memorial (3VS), that contain numbers in the identifier, do not require the 'K' prefix. Many foreign countries use two letter prefixes. For more information on ICAO identifiers, contact:

Document Sales Unit
International Civil Aviation Organization
999 University Street
Montreal, Quebec
Canada H3C 5H7

Section 6 WPT Pages

WPT Page Group

Section 2 introduced the GNC 420's main page groups—NAV, WPT, AUX,—and described each page in the NAV group. This second page group (WPT) provides information for the thousands of airports, VORs, NDBs, intersections, runways, frequencies and procedures stored on your Jeppesen NavData® card. A WPT page is also provided to display information for up to 1,000 user-created waypoints.

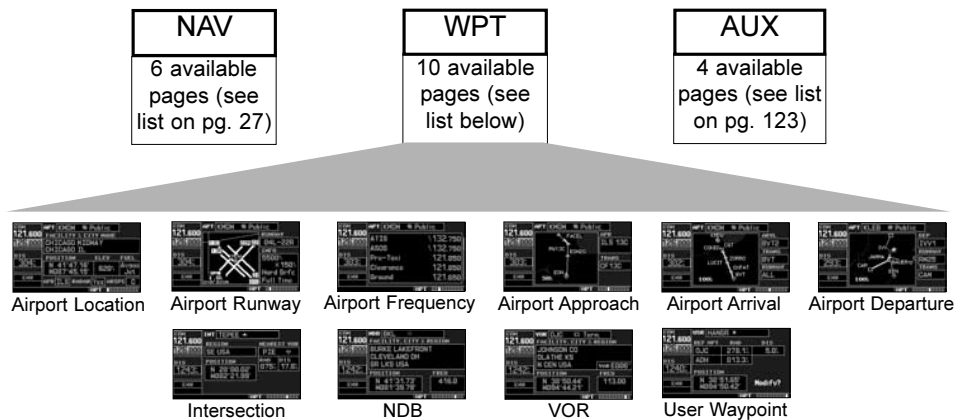

To quickly select a WPT page:

1. From any page, press and hold **CLR** to select the default NAV page. (You may skip this step if you are already viewing any of the main pages. See page 27.)
2. Rotate the large right knob (⊙) to select the WPT page group. "WPT" will appear in the lower right corner of the screen.
3. Rotate the small right knob (⊙) to select the desired WPT page.

The WPT page group includes ten pages. While viewing any WPT page, rotate the small right knob (PUSH CRSR) to select a different WPT page. The first six pages provide detailed information for the selected airport: location, runways, frequencies, approaches, arrivals, and departures. The last four pages provide information for intersections, NDBs, VORs and user-created waypoints.

After a WPT page is selected, information for a waypoint may be viewed by entering the identifier (or name) of the desired waypoint. Airports, NDBs and VORs may be selected by identifier, facility name or location (city).

To enter a waypoint identifier:

1. Select the desired WPT page and press the small right knob (PUSH CRSR) to activate the cursor.
2. Rotate the small right knob (PUSH CRSR) to select the first character of the waypoint's identifier.
3. Rotate the large right knob (CRSR) to select the next character field.
- 4a. Rotate the small right knob (PUSH CRSR) to select the desired character.
5. Repeat steps 3 and 4 until the identifier is selected, then press ENT.
- 6a. To remove the flashing cursor, press the small right knob (PUSH CRSR).

To enter a waypoint facility name or city location:

1. Select the airport location page, NDB page or VOR page from the WPT page group. (See page 86.)
2. Press the small right knob (PUSH CRSR) to activate the cursor.
3. Rotate the large right knob (CRSR) to select the facility name or location (city) field.
- 4b. Rotate the small right knob (PUSH CRSR) to select the desired character.
5. Rotate the large right knob (CRSR) to select the next character field.
- 6b. Repeat steps 4 and 5 until the facility name or location is selected, then press ENT.
7. To remove the flashing cursor, press the small right knob (PUSH CRSR).

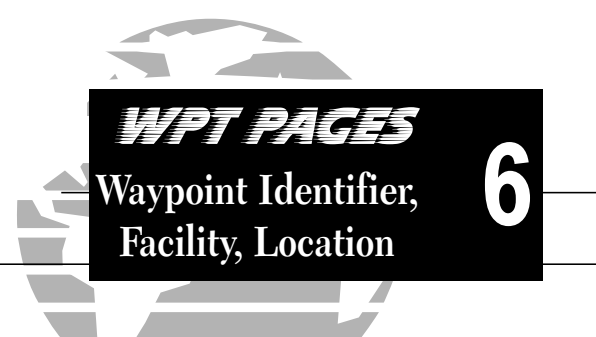

4 b

COM 118.000	APT MYAW Private
119.200	FACILITY & CITY NAME WALKER S CAY ABACO_BAHAMAS
DIS 82.5 _m	POSITION ELEV FUEL N 27°16.00' W078°24.00' 10 _{ft} Jet
ENR	APR VFR RADAR No ARSPC
HSG WPT 0000000000	

6 b

COM 118.000	APT KABQ Public
119.200	FACILITY & CITY NAME ALBUQUERQUE INTL SUNPOR ALBUQUERQUE_NM
DIS 81.1 _m	POSITION ELEV FUEL N 35°02.42' W106°36.56' 5350 _{ft} Avgas Jet
ENR	APR ILS RADAR Yes ARSPC C
HSG WPT 0000000000	

6 b

COM 118.000	VOR ABQ Hi Alt.
119.200	FACILITY, CITY & REGION ALBUQUERQUE ALBUQUERQUE_NM
DIS 79.7 _m	SW USA VAR E013°
ENR	POSITION FREQ N 35°02.63' W106°48.98' 113.20
HSG WPT 0000000000	

6

WPT PAGES

Duplicate Waypoints

2 a

COH	APT	KAEG	Public
118.000	FACILITY & CITY NAME		
119.200	DOUBLE EAGLE II		
	ALBUQUERQUE_NM		
DIS	POSITION	ELEV	FUEL
76.7 _m	N 35°08.71'	5830'	Avgas
	W106°47.71'		Jet
ENR	APR	ILS	RADAR Yes ARSPC
HSG WPT 0000000000			

3 a

COH	APT	4AC	Public
118.000	FACILITY & CITY NAME		
119.200	CORONADO		
	ALBUQUERQUE_NM		
DIS	POSITION	ELEV	FUEL
73.9 _m	N 35°11.75'	5280'	Avgas
	W106°34.40'		
ENR	APR	VFR	RADAR No ARSPC C
HSG WPT 0000000000			

2 b

COH	DUPLICATE WAYPOINTS		
118.000	WPT AB		
119.200	NDB		
	N GEN USA		
DIS	NDB		
71.9 _m	S GEN USA		
ENR			
HSG WPT 0000000000			

Duplicate Waypoints

Once the identifier, facility name or location is entered, all six airport pages will display information for the selected airport. As you enter an identifier, facility name or location, the GNC 420's Spell'N'Find™ feature will scroll through the database, displaying those waypoints matching the characters you have entered to that point. If duplicate entries exist for the entered facility name or location, additional entries may be viewed by continuing to rotate the small right knob (PUSH) during the selection process (see page 87). If duplicate entries exist for an entered identifier, a duplicate waypoint page will appear once you select the identifier (by pressing ENT).

To select a facility name or location, where duplicate entries exist:

1. Select the desired facility name or location, following the steps on page 87.
- 2a. As you spell the facility name or location, using the small (PUSH) and large (PUSH) right knobs, the GNC 420's Spell'N'Find feature will select the first entry in the database based upon the characters you have entered up to that point.
- 3a. Continue rotating the small right knob (PUSH) to scroll through any additional database listings for the selected facility name or location. You can scroll backwards with the small right knob (PUSH) if you scroll past the desired facility name or location.
4. Press ENT to select the desired facility name or location.
5. To remove the flashing cursor, press the small right knob (PUSH).

To select a waypoint identifier from a list of duplicates:

1. Select the desired airport or navaid identifier following the steps on page 87.
- 2b. A duplicate waypoints window will appear. Rotate the large right knob (PUSH) to select the desired waypoint and press ENT.
- 3b. To remove the flashing cursor, press the small right knob (PUSH).

Airport Location Page

Airport Identifier, Symbol and Type	COH 121.200 119.750	APT KPHX Public	Facility Name and Location (city)
Latitude/Longitude Position	DIS 304 ⁿ _m	FACILITY & CITY NAME PHOENIX SKY HARBOR INTL PHOENIX AZ	Field Elevation, Available Fuels and Airspace Type
Best Available Approach and Radar Coverage	ENR	POSITION ELEV FUEL N 33°26.16' W112°00.57' 1130 ^f Avgas Jet	First Page in WPT group
		APR ILS RADAR Yes ARSPC B	
		HSG HPT 0000000000	

The *airport location page* displays the latitude, longitude, and elevation of the selected airport. The *airport location page* also displays facility name and location, as well as fuel availability, available approaches, radar coverage and airspace type. The following descriptions and abbreviations are used:

- Type— Usage type: Public, Military or Private
- Position— Latitude/Longitude (degrees/minutes or degrees/minutes/seconds), MGRS or UTM/UPS
- Elevation— In feet or meters
- Fuel— For public-use airports, the available fuel type(s) are: Avgas (80-87/100LL/100-130/Mogas), Jet, or None
- Approach— Best available approach: ILS, MLS, LOC, LDA, SDF, GPS, VOR, RNAV (“RNV”), LORAN (“LOR”), NDB, TACAN (“TCN”), Helicopter (“HEL”), or VFR
- Radar— Radar coverage: Yes or No
- Airspace— Control environment: Class C, CTA, TMA, TRSA, Class B or none

COH	121.200	119.750	APT KDVT Public
DIS	304 ⁿ _m		FACILITY & CITY NAME PHOENIX DEER VALLEY MUN PHOENIX AZ
ENR			POSITION ELEV FUEL N 33°41.30' W112°04.95' 1480 ^f Avgas Jet
			APR GPS RADAR Yes ARSPC B
			HSG HPT 0000000000

COH	121.200	119.750	APT P18 Military
DIS	304 ⁿ _m		FACILITY & CITY NAME PAPAGO AAF PHOENIX AZ
ENR			POSITION ELEV FUEL N 33°28.31' W111°57.82' 1250 ^f Jet
			APR VFR RADAR No ARSPC B
			HSG HPT 0000000000

6

WPT PAGES Airport Runways



Airport Runway Page

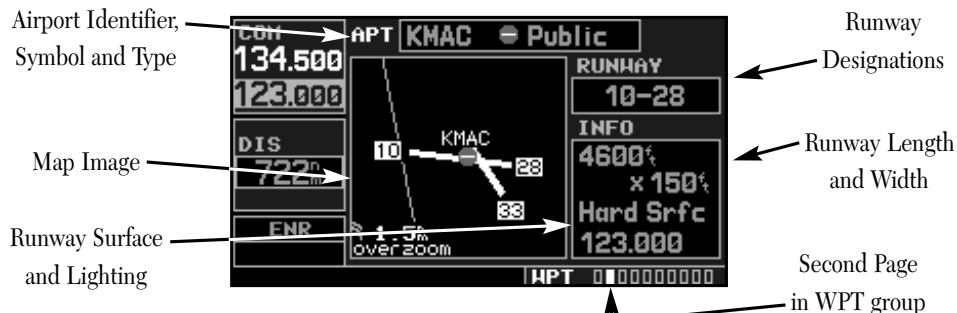

The *airport runway page* displays runway designations, length, surface type and lighting for the selected airport. The pcl frequency can be transferred to the stand-by com window by highlighting and pressing **ENT**. A map image of the runway layout and surrounding area is also displayed. The map image scale appears in the lower left corner and is adjustable using the **▽ RING △** key. For airports with multiple runways, information for each runway is available.

To display information for each additional runway:

1. Press the small right knob (**PUSH CRSR**) to activate the cursor.
- 2a. Rotate the large right knob (**CRSR**) to place the cursor on the runway designation field.
3. Rotate the small right knob (**PUSH CRSR**) to display a window listing all runways for the selected airport.
4. Continue rotating the small right knob (**PUSH CRSR**) to select the desired runway.
5. Press **ENT** to display information for the selected runway on the airport runway page.
6. To remove the flashing cursor, press the small right knob (**PUSH CRSR**).

To adjust the scale of the map image:

1. Press the down arrow side of the **▽ RING △** key to display a smaller map area.
- 2b. Press the up arrow side of the **▽ RING △** key to display a larger map area.

The following descriptions and abbreviations are used on the airport runway page:

- Type— Usage type: Public, Military or Private
- Surface— Runway surface types include: Hard, Turf, Sealed, Gravel, Dirt, Soft, Unknown or Water
- Lighting— Runway lighting types include: No Lights, Part Time, Full Time, Unknown or Frequency (for pilot-controlled lighting)

Airport Frequency Page

Annotations for the Airport Frequency Page:

- Airport Identifier, Symbol and Type: Points to the top header area showing 'APT KPHX Public'.
- Frequency: Points to the list of frequencies (e.g., 132.550, 118.700).
- Frequency Type: Points to the list of frequency types (e.g., Ground, Tower, Unicom).
- Usage Restrictions Information: Points to the 'TERM' field at the bottom.
- Scroll Bar: Points to the vertical bar on the right side of the frequency list.
- Third Page in WPT group: Points to the 'HSG | WPT' indicator at the bottom.

The *airport frequency page* displays radio frequencies and frequency types for the selected airport, as well as sector and altitude restrictions (where applicable). If the selected airport has an ILS approach, the localizer frequency(s) is also listed on the *airport frequency page*. The *airport frequency page* may be used to quickly select and tune a COM frequency. (VLOC frequency is for reference only.)

To scroll through the frequency list and tune to a desired frequency on the list:

1. Press the small right knob (PUSH CRB) to activate the cursor.

{continued}



2 a

COM 121.200
119.750
DIS 12.1 n m
TERM

APT KPHX Public

Ground 132.550
Tower 118.700
Tower 120.900
Unicom 122.950
Departure 119.200

ATIS 124.300
Clearance 118.100
Ground 119.750
Ground 132.550
Tower 118.700

HSG | WPT 0000000000

3 a

COM 121.200
118.700
DIS 12.1 n m
TERM

APT KPHX Public

Clearance 118.100
Ground 119.750
Ground 132.550
Tower 118.700
Tower 120.900

HSG | WPT 0000000000

6

WPT PAGES Airport Frequencies

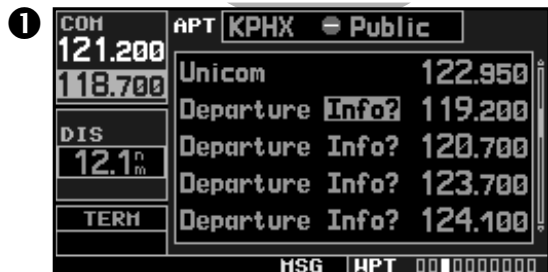

- 2a. Rotate the large right knob (⊙) to scroll through the list, placing the cursor on the desired frequency. If there are more frequencies in the list than can be displayed on the screen, a scroll bar along the right-hand side of the screen will indicate where you are within the list.
- 3a. Press **ENT** to place the selected frequency in the standby field of the COM window.
4. To remove the flashing cursor, press the small right knob (PUSH CURS).

Some listed frequencies may include designations for limited usage, as follows:

“TX” - transmit only

“RX” - receive only

“PT” - part time frequency

If a listed frequency has sector or altitude restrictions, the frequency will be preceded by an “Info?” designation.

To view usage restrictions for a frequency:

1. Rotate the large right knob (⊙) to place the cursor on the “Info?” designation directly to the left of the desired frequency.
- 2b. Press **ENT** to display the restriction information.
- 3b. To return to the airport frequency page, press **ENT**.

WPT PAGES Airport Frequencies

6

The following descriptions and abbreviations are used on the airport frequency page:

- Type— Usage type: Public, Military or Private
- Frequency— Communication frequencies which may include restrictions:

Approach	Arrival	Class B
Class C	CTA	Departure
TMA	Terminal	TRSA

Communication frequencies without restrictions:

ATIS	ASOS	AWOS
Center	Clearance	Gate
Control	Ground	Helicopter
Multicom	Pre-taxi	Radar
Ramp	Other	Tower
	Unicom	

Navigation frequencies:

ILS	LOC
-----	-----

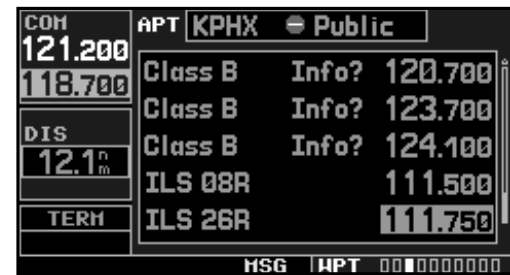

6

WPT PAGES Airport Approaches

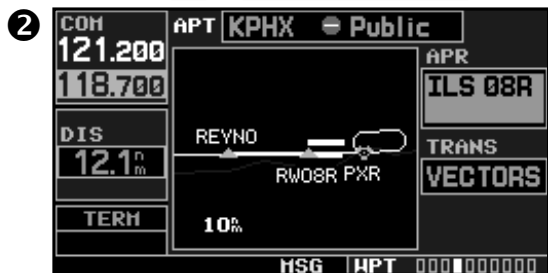

Airport Approach Page

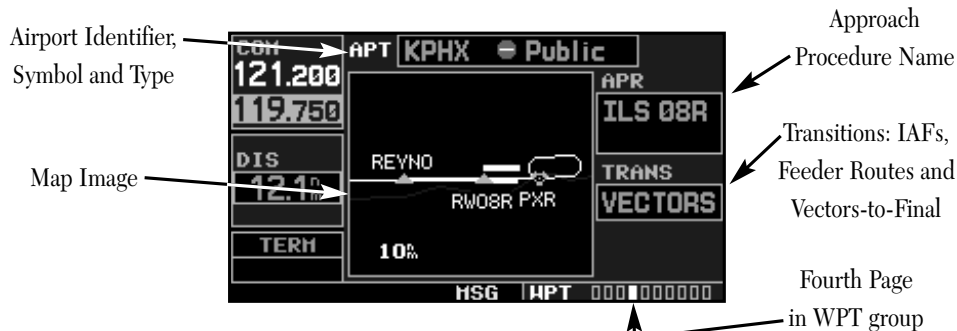

The *airport approach page* shows the available approach procedures for the selected airport. Where multiple initial approach fixes (IAFs) and feeder routes are available, that information may also be displayed. A map image provides a layout diagram for each approach and transition.

To scroll through the available approaches and transitions:

1. Press the small right knob (PUSH CRSR) to activate the cursor.
2. Rotate the large right knob (CRS) to place the cursor on the approach (APR) procedure name field.
3. Rotate the small right knob (PUSH CRSR) to display a window of available approaches for the selected airport. Continue rotating the small right knob (PUSH CRSR) to select the desired approach.
4. Press ENT. The cursor moves to the transitions (TRANS) field.
5. Rotate the small right knob (PUSH CRSR) to display a window of available transitions. Continue rotating the small right knob (PUSH CRSR) to select the desired transition or select "VECTORS" for guidance only along the final course segment of the approach.
6. Press ENT. To remove the flashing cursor, press the small right knob (PUSH CRSR).

NOTE

Not all approaches in the database are approved for GPS use. As you select an approach, a “GPS” designation to the right of the procedure name indicates the procedure can be flown using the GPS receiver. Some procedures will not have this designation, meaning the GPS receiver may be used for supplemental navigation guidance only. ILS approaches, for example, must be flown by tuning the external VLOC receiver to the proper frequency and following the CDI or HSI.

Airport Approach Page Options

The following options are available for the *airport approach page*, by pressing the **MENU** key:

Load into Active FPL? allows you to load the selected approach into the active flight plan—without activating it. This performs the same operation as selecting “Load?” from the *procedures page* “Select Approach?” option. See page 66.

To load an approach from the airport approach page:

1. Select the desired approach and transition using the steps outlined on page 94.
2. Press **MENU** to display the airport approach page options.
3. Rotate the large right knob (⊖) to highlight “Load into Active FPL?” and press **ENT**.
4. The active flight plan page will appear. Press **FPL** to return to the airport procedures page.

Load and Activate? allows you to load the selected approach into the active flight plan and activate navigation guidance to the approach transition. See page 67.

To load and activate an approach from the airport approach page, follow the steps above, but select “Load and Activate?” in step #3.

WPT PAGES

Airport Approaches

6

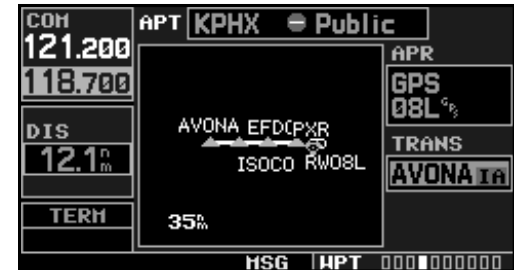

6

WPT PAGES

Airport Arrivals



Airport Arrival Page

Airport Identifier,
Symbol and Type

Map Image



Arrival Procedure

Name

Transitions

Runways Associated
with Arrival

Fifth Page

in WPT group

The *airport arrival* page shows the available Airport Standard Terminal Arrival (STAR) procedures for the selected airport. Where multiple transitions or runways are associated with the arrival procedure, that information may also be displayed. A map image provides a layout diagram for each arrival, transition and runway.

To scroll through the available arrivals:

1. Press the small right knob (PUSH CRSR) to activate the cursor.
2. Rotate the large right knob (CRS) to place the cursor on the arrival (ARVL) procedure name field.
3. Rotate the small right knob (PUSH CRSR) to display a window of available arrivals for the selected airport. Continue rotating the small right knob (PUSH CRSR) to select the desired arrival.
4. Press ENT. The cursor moves to the transitions (TRANS) field.
5. Rotate the small right knob (PUSH CRSR) to display a window of available transitions. Continue rotating the small right knob (PUSH CRSR) to select the desired transition.
6. Press ENT. The cursor moves to the runway field.

{continued}

7. Rotate the small right knob (PUSH) to display a window of available runways. Continue rotating the small right knob (PUSH) to select the desired runway. ("ALL" may appear in the runway field, indicating the arrival procedure applies to all runways. For airports with parallel runways, "B" may appear at the end of the runway designation to indicate the arrival procedure applies to both runways.)

8. Press ENT. To remove the flashing cursor, press the small right knob (PUSH).

Airport Arrival Page Options

The following option is available for the *airport arrival page*, by pressing the MENU key:

Load into Active FPL? allows you to load the selected arrival into the active flight plan. This is identical to loading an arrival procedure from the *procedures page*, as described on page 66.

To load an arrival procedure from the airport arrival page:

1. Select the desired arrival, transition and runway using the steps above.
2. Press MENU to display the airport arrival page options.
3. Press ENT to select the "Load into Active FPL?" option.
4. The active flight plan page will appear. Press FPL to return to the airport arrival page.

WPT PAGES

Airport Arrivals

6



7



3

6

WPT PAGES Airport Departures



Airport Departure Page

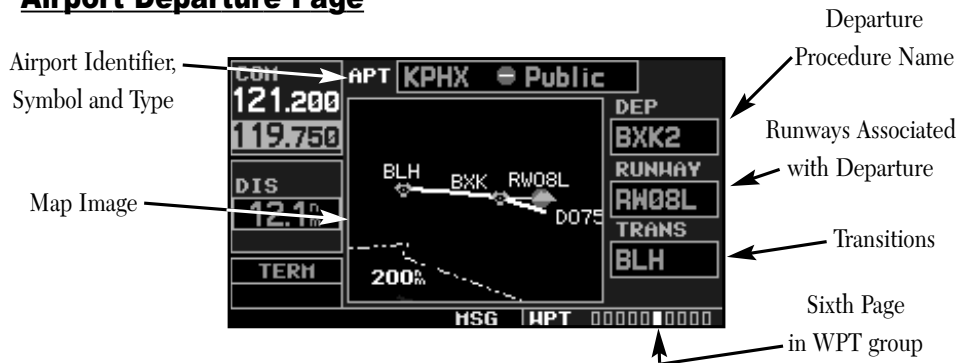

The *airport departure page* shows the available Airport Standard Instrument Departure (SID) procedures for the selected airport. Where multiple runways or transitions are associated with the departure procedure, that information may also be displayed. A map image provides a layout diagram for each departure, runway and transition.

To scroll through the available departures:

1. Press the small right knob (PUSH CHR) to activate the cursor.
2. Rotate the large right knob (C) to place the cursor on the departure (DEP) procedure name field.
3. Rotate the small right knob (PUSH CHR) to display a window of available departures for the selected airport. Continue rotating the small right knob (PUSH CHR) to select the desired departure.
4. Press ENT. The cursor moves to the runway field.

{continued}

5. Rotate the small right knob (PUSH CRSR) to display a window of available runways. Continue rotating the small right knob (PUSH CRSR) to select the desired runway. ("ALL" may appear in the runway field, indicating the departure procedure applies to all runways. For airports with parallel runways, "B" may appear at the end of the runway designation to indicate the departure procedure applies to both runways.)
6. Press ENT. The cursor moves to the transitions (TRANS) field.
7. Rotate the small right knob (PUSH CRSR) to display a window of available transitions. Continue rotating the small right knob (PUSH CRSR) to select the desired transition.
8. Press ENT. To remove the flashing cursor, press the small right knob (PUSH CRSR).

Airport Departure Page Options

The following option is available for the *airport departure page*, by pressing the MENU key:

Load into Active FPL? allows you to load the selected departure into the active flight plan. This is identical to loading a departure procedure from the *procedures page*, as described on page 66.

To load a departure procedure from the airport departure page:

1. Select the desired departure, runway and transition using the steps above.
2. Press MENU to display the airport departure page options.
3. Press ENT to select the "Load into Active FPL?" option.
4. The active flight plan page will appear. Press FPL to return to the airport departure page.

WPT PAGES

Airport Departures

6



5



3

6

WPT PAGES Intersections

COI 134.900	INT ROBYN ▲	REGION HAWAII	NEAREST VOR IAI ↕
DIS 2738 ⁿ _m	POSITION N 19°44.25' W156°08.22'	RAD 298 ^o _M	DIS 8.1 ⁿ _m
ENR	HPT 0000001000		

COI 134.900	INT DONGS ▲	Done?	REGION SE USA	NEAREST VOR OMN ↕
DIS 65.0 ⁿ _m	POSITION N 29°08.82' W081°13.39'	RAD 217 ^o _M	DIS 11.0 ⁿ _m	
ENR	HPT 0000001000			

COI 134.900	INT EIEIO ▲	REGION N CEN USA	NEAREST VOR DSM ↕
DIS ----- ⁿ _m	POSITION N 41°53.74' W093°53.86'	RAD 335 ^o _M	DIS 29.7 ⁿ _m
ENR	HPT 0000001000		

Intersection Page

Intersection Identifier and Symbol: COI 134.900

Region/Country: REGION S CEN USA

Latitude/Longitude Position: POSITION N 32°33.73' W096°19.90'

Nearest VOR and Symbol: NEAREST VOR COY ↕

Radial and Distance from Nearest VOR: RAD 341^o_M DIS 23.3ⁿ_m

Seventh Page in WPT group: HSG | HPT 0000001000

The *intersection page* displays the latitude, longitude, region and country for the selected intersection. The *intersection page* also displays the identifier, radial and distance from the nearest VOR, VORTAC or VOR/DME. The following descriptions and abbreviations are used:

- Position— Latitude/Longitude (degrees/minutes or degrees/minutes/seconds), MGRS or UTM/UPS
- RAD— Radial from nearest VOR in degrees magnetic or degrees true (depending upon unit configuration)
- DIS— Distance from nearest VOR, in nautical miles/statute miles/kilometers (depending upon unit configuration)

NOTE

The VOR displayed on the intersection page is the nearest VOR, not necessarily the VOR used to define the intersection.

Intersections may only be selected by identifier, as described on page 87.

NDB Page

Diagram illustrating the NDB page layout with callouts:

- NDB Identifier and Symbol:** Points to the 'NDB AA' field.
- Facility Name, City and Region/Country:** Points to the 'FACILITY, CITY & REGION' section.
- Frequency and Weather Broadcast Indication:** Points to the 'FREQ' and 'Wx Brdct' fields.
- Latitude/Longitude Position:** Points to the 'POSITION' section.
- Eighth Page in WPT group:** Points to the 'IHP' indicator at the bottom.

The *NDB page* displays the facility name, city, region/country, latitude and longitude for the selected NDB. The *NDB page* also displays the frequency and a weather broadcast indication (if applicable). The following descriptions and abbreviations are used:

- **Symbol**— See page 31 for a graphic illustration of available NDB symbols
- **Position**— Latitude/Longitude (degrees/minutes or degrees/minutes/seconds), MGRS or UTM/UPS
- **FREQ**— Frequency in kilohertz (kHz) (NDB frequency is for reference only.)
- **Wx Brdct**— Weather information is broadcast on the selected facility's frequency

As mentioned on page 87, NDBs may be selected by identifier, facility name or location (city).



COH	NDB CAT	
133.000	FACILITY, CITY & REGION	
124.300	CHATHAM	
	CHATHAM NJ	
DIS	NE USA	
459 ⁿ _m	POSITION	FREQ
	N 40°44.45'	254.0
ENR	W074°25.79'	
IHP 0000000000		

COH	NDB FFL	
133.000	FACILITY, CITY & REGION	
124.300	FAIRFIELD	
	FAIRFIELD IA	
DIS	N CEN USA	
461 ⁿ _m	POSITION	FREQ
	N 41°00.67'	332.0
ENR	W091°59.31'	
IHP 0000000000		

6

WPT PAGES

VORs

COH	VOR	FLL	Hi Alt.
133.000	FACILITY, CITY & REGION		
124.300	FORT LAUDERDALE FORT LAUDERDALE FL		
DIS	SE USA	VAR	E000°
496 _m	POSITION	FREQ	
ENR	N 26°04.48'	114.40	
	W080°09.15'		
HPT 0000000000			

COH	VOR	HSD	Hi Alt.
133.000	FACILITY, CITY & REGION		
124.300	HAAMSTEDE		
DIS	NETHERLND	VAR	W003°
398 _m	POSITION	FREQ	
ENR	N 51°43.37'	114.15	
	E003°51.50'		
HPT 0000000000			

VOR Page

VOR Identifier and Symbol

Facility Name, City and Region/Country

Latitude/Longitude Position

COH	VOR	FMG	Hi Alt.
133.000	FACILITY, CITY & REGION		
124.300	MUSTANG RENO NV SW USA		
DIS	VAR	E016°	
489 _m	POSITION	FREQ	
ENR	N 39°31.87'	117.90	
	W119°39.36'	Wx Brdcst	
HPT 0000000000			

Magnetic Variation

Frequency and Weather Broadcast Indication

Ninth Page in WPT group

The *VOR page* displays the facility name, city, region/country, magnetic variation, latitude and longitude for the selected VOR. The *VOR page* also displays the frequency and a weather broadcast indication (if applicable). The following descriptions and abbreviations are used:

- Symbol— See page 31 for a graphic illustration of available VOR symbols
- VAR— Magnetic variation in degrees
- Position— Latitude/Longitude (degrees/minutes or degrees/minutes/seconds), MGRS or UTM/UPS
- FREQ— Frequency in megahertz (MHz)
- Wx Brdcst— Weather information is broadcast on the selected facility's frequency

As mentioned on page 85, VORs may be selected by identifier, facility name or location (city). The *VOR* frequency is provided for reference only to help quickly tune the external VLOC receiver to the selected VOR's frequency.

User Waypoint Page

Annotations for the HANGR waypoint page:

- User Waypoint Name: Points to the **USR HANGR** field.
- Reference Waypoint Information: Points to the REF HPT, RAD, and DIS fields.
- Create/Modify Action Field: Points to the **Modify?** button.
- Tenth Page in WPT group: Points to the **WPT 0000000000** indicator at the bottom.
- Latitude/Longitude Position: Points to the POSITION field.

COH	USR	HANGR	
121.600	REF HPT	RAD	DIS
126.000	DJC	278.1° _M	5.0 _n ^m
DIS	ADH	013.3° _M	
1240 _n ^m	POSITION		Modify?
ENR	N 38°51.65'		W094°50.42'
WPT 0000000000			

In addition to the airport, VOR, NDB and intersection information contained in your Jeppesen NavData® card, the GNC 420 allows you to store up to 1,000 user-defined waypoints. The user waypoint page displays the waypoint name (up to five characters long), identifier and radial from two reference waypoints, distance from one reference waypoint, along with the user waypoint's latitude/longitude position.

The following descriptions and abbreviations are displayed on the *user waypoint page*:

- REF WPT— Reference waypoint identifier (name)
- RAD— Radial from reference waypoint, in degrees magnetic or degrees true (depending upon unit configuration)
- DIS— Distance from reference waypoint, in nautical miles/statute miles/kilometers (depending upon unit configuration)
- Position— Latitude/Longitude (degrees/minutes or degrees/minutes/seconds), MGRS or UTM/UPS

User waypoints may only be selected by name (identifier), as described on page 87.



COH	USR	HOME	
133.000	REF HPT	RAD	DIS
124.300	DJC	283.7° _M	2.7 _n ^m
DIS	MKC	192.1° _M	
637 _n ^m	POSITION		Modify?
ENR	N 38°51.33'		W094°47.41'
WPT 0000000000			

COH	USR	LAKE	
133.000	REF HPT	RAD	DIS
124.300	RIL	257.6° _M	19.4 _n ^m
DIS	DBL	263.5° _M	
559 _n ^m	POSITION		Modify?
ENR	N 39°31.50'		W108°08.10'
WPT 0000000000			

6

WPT PAGES

Creating User Waypoints

2

COH 123.000	USR BVDAM	REF	HPT	RAD	DIS
122.950					
DIS					
ENR					
POSITION					
HSG HPT 0000000000					

3

COH 123.000	USR BVDAM	REF	HPT	RAD	DIS
122.950		RZC		001.3 ^o _M	7.6 ⁿ _m
DIS		DAK		005.5 ^o _M	
ENR					
POSITION					
N 36°22.35' Create?					
W094°06.42'					
HSG HPT 0000000000					

4

COH 123.000	USR BVDAM	REF	HPT	RAD	DIS
122.950		RZC		001.3 ^o _M	7.6 ⁿ _m
DIS		DAK		005.5 ^o _M	
ENR					
POSITION					
N 36°25.53' Create?					
W093°50.42'					
HSG HPT 0000000000					

Creating User Waypoints

User waypoints may be created from the *user waypoint page* or the *map page*. To create a new user waypoint, simply enter its name (identifier) and position, or reference another waypoint by radial and distance.

To create a new user waypoint by entering its latitude/longitude position:

1. With the user waypoint page displayed, press the small right knob (PUSH CRSR) to activate the cursor.
2. Use the small (PUSH CRSR) and large (CRSR) right knobs to enter a name for the new waypoint and press ENT. Your present position appears in the position field at the bottom of the page. To create a waypoint at your present position, rotate the large right knob (CRSR) to highlight "Create?" and skip to step #6.
3. Rotate the large right knob (CRSR) to highlight the position field at the bottom of the page.
4. Use the small (PUSH CRSR) and large (CRSR) right knobs to enter the position coordinates for the new waypoint.
5. Press ENT to accept the selected position.
6. The cursor moves to "Create?". Press ENT to add the new waypoint to memory.
7. Press the small right knob (PUSH CRSR) to remove the flashing cursor.

To create a new user waypoint by referencing an existing waypoint:

1. With the user waypoint page displayed, press the small right knob (PUSH CRSR) to activate the cursor.
2. Use the small (PUSH CRSR) and large (CRSR) right knobs to enter a name for the new waypoint and press ENT.
3. Rotate the large right knob (CRSR) to highlight the first reference waypoint (REF WPT) field.
4. Use the small (PUSH CRSR) and large (CRSR) right knobs to enter the identifier of the reference waypoint. The reference waypoint can be an airport, VOR, NDB, intersection or another user waypoint. Press ENT to accept the selected identifier.
5. The cursor moves to the radial (RAD) field. Use the small (PUSH CRSR) and large (CRSR) right knobs to enter the radial from the reference waypoint to the new user waypoint. Press ENT to accept the selected radial.
6. The cursor moves to the distance (DIS) field. Use the small (PUSH CRSR) and large (CRSR) right knobs to enter the distance from the reference waypoint to the new user waypoint. Press ENT to accept the selected distance.
7. Rotate the large right knob (CRSR) to highlight "Create?" and press ENT.
8. Press the small right knob (PUSH CRSR) to remove the flashing cursor.

NOTE

The GNC 420 allows you to create a new user waypoint at a defined radial and distance from your present position. To reference your present position, follow the steps above, but press CLR in step #4. "P.POS" will appear in the reference waypoint (REF WPT) field to indicate that radial and distance information will reference your present position.

The second reference waypoint field (REF WPT) is a temporary reference only—not a reference that will be stored with the user waypoint. By default, this field will display a radial from the nearest VOR. However, you can select any waypoint—by identifier—to use as a reference in this field.

Your GNC 420 can store user-defined waypoints which are generated from other equipment in your panel. For example, an EFIS equipped with joystick inputs can be used to create user waypoints which will (if your installation supports this) automatically transfer to your GNC 420.

WPT PAGES
Creating User Waypoints
6



6

WPT PAGES

Creating / Modifying User Waypoints

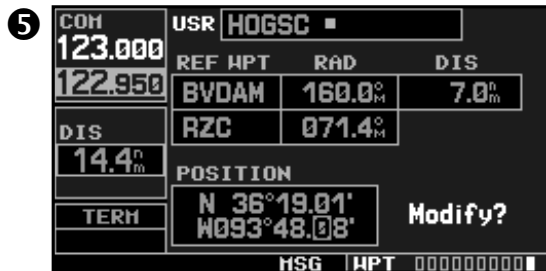

Creating User Waypoints from the Map Page

The *map page* and panning target pointer (see page 33) provide a quick means of saving your present position as a user-defined waypoint.

To capture and save your present position as a user waypoint:

- 1a. With the map page displayed, press the small right knob (PUSH CRSR) to activate the panning function. The target pointer will appear at your present position.
- 2a. Press ENT to capture the position and display the user waypoint page.
3. A four-digit name is automatically assigned to the waypoint. To change this name, rotate the large right knob (CRSR) to highlight the name field, then use the small (PUSH CRSR) and large (CRSR) right knobs to select a new name. Press ENT to accept the selected name.
- 4a. The cursor moves to the "Create?" action field. Press ENT to save the new waypoint.

Modifying User Waypoints

To modify an existing waypoint, select that waypoint on the user waypoint page and enter the new position information directly over the old information.

To modify a user waypoint by changing its latitude/longitude position:

- 1b. With the user waypoint page displayed, press the small right knob (PUSH CRSR) to activate the cursor.
- 2b. Use the small (PUSH CRSR) and large (CRSR) right knobs to enter the name of the desired waypoint and press ENT.
3. Rotate the large right knob (CRSR) to highlight the position field at the bottom of the page.
- 4b. Use the small (PUSH CRSR) and large (CRSR) right knobs to enter the new position coordinates and press ENT to accept the selected position.
5. The cursor moves to the "Modify?" action field. Press ENT to modify the waypoint.
6. Press the small right knob (PUSH CRSR) to remove the flashing cursor.

To modify a user waypoint by changing reference waypoint information:

1. With the user waypoint page displayed, press the small right knob (PUSH CRSR) to activate the cursor.
2. Use the small (PUSH CRSR) and large (CRSR) right knobs to enter the name of the desired waypoint and press ENT.
3. Rotate the large right knob (CRSR) to highlight the first reference waypoint (REF WPT) field, if you wish to change the reference waypoint. Otherwise, continue rotating the large right knob (CRSR) to highlight the radial (RAD) or distance (DIS) field, as desired.
4. Use the small (PUSH CRSR) and large (CRSR) right knobs to change the identifier—if desired—of the reference waypoint. The reference waypoint can be an airport, VOR, NDB, intersection or another user waypoint. Press ENT to accept the selected identifier.
5. The cursor moves to the radial (RAD) field. Use the small (PUSH CRSR) and large (CRSR) right knobs to change the radial from the reference waypoint, if desired. Press ENT to accept the selected radial.
6. The cursor moves to the distance (DIS) field. Use the small (PUSH CRSR) and large (CRSR) right knobs to change the distance from the reference waypoint to the new user waypoint, if desired. Press ENT to accept the selected distance.
7. The cursor moves to the “Modify?” action field. Press ENT to modify the waypoint.
8. Press the small right knob (PUSH CRSR) to remove the flashing cursor.

NOTE

If you attempt to modify or delete a waypoint which is currently a direct-to waypoint or the current “from” or “to” waypoint in the active flight plan, the GNC 420 will alert you with the “Can’t change an active waypoint” or “Waypoint is active and can’t be deleted” message. You must first cancel the direct-to or remove the waypoint(s) from the active flight plan before modifying or deleting the waypoint(s).

WPT PAGES
Creating / Modifying
User Waypoints

6



4



5



6

6

WPT PAGES

Deleting Waypoints User Waypoint List



User Waypoint Page Options

The following *user waypoint page* options are available by pressing the **MENU** key:

View User Waypoint List? displays a list of all user waypoints currently stored in memory.

To view a list of all user waypoints:

1. From the user waypoint page, press **MENU** to display the user waypoint page options.
- 2a. Rotate the large right knob (⊖) to highlight "View User Waypoint List?" and press **ENT**.
3. The top of the user waypoint list will indicate the total number of user waypoints currently used and available memory. If more user waypoints are stored than can be displayed on a single screen, rotate the large right knob (⊖) to scroll through the user waypoint list.
4. Press the small right knob (⊕) to return to the user waypoint page.

Delete User Waypoint? allows you to delete the selected waypoint from memory.

To delete a user waypoint:

1. Select the desired waypoint on the user waypoint page and press **MENU** to display the user waypoint page options.
- 2b. Rotate the large right knob (⊖) to highlight "Delete User Waypoint?" and press **ENT**.



User Waypoint List

The user waypoint list allows you to review, modify, rename or delete a selected user waypoint, or to delete all user waypoints currently stored in memory. At the top of the page are indications for number of waypoint locations used and available memory.

To review and/or modify a user waypoint from the user waypoint list:

1. Select the user waypoint list, as described on page 108.
2. Rotate the large right knob (⌚) to highlight the desired user waypoint.
- 3a. Press **ENT** to display the user waypoint page for the selected waypoint. From this page you may review all information defining the waypoint and its position.
- 4a. To modify the waypoint's position or reference waypoint information, follow the steps described on page 106 and 107. (Keep in mind that you've already selected a user waypoint page which displays the desired user waypoint, so you may skip the first two steps of the procedure on page 106 or 107.)
5. To exit the user waypoint page, rotate the large right knob (⌚) to highlight "Done?" and press **ENT**.

To rename a user waypoint from the user waypoint list:

1. Select the user waypoint list, as described on page 108.
2. Rotate the large right knob (⌚) to highlight the desired user waypoint.
- 3b. Use the small (⌚) and large (⌚) right knobs to change the name of the user waypoint. (Enter the new name directly over the old name.) Press **ENT** to accept the new name.
- 4b. A "rename waypoint" confirmation window is displayed. With "Yes?" highlighted, press **ENT** to rename the selected user waypoint.

To delete a user waypoint from the user waypoint list:

1. Select the user waypoint list, as described on page 108.
2. Rotate the large right knob (⌚) to highlight the desired user waypoint.
- 3c. Press **CLR** to display a "delete waypoint" confirmation window.
- 4c. With "Yes?" highlighted, press **ENT** to delete the selected user waypoint.

WPT PAGES

Modifying / Deleting User Waypoints

6



WPT PAGES

6

Deleting All User Waypoints



To delete all user waypoints from memory:

1. Select the user waypoint list, as described on page 108.
2. Press **MENU** to display an options window for the user waypoint list.
3. With "Delete All User Waypoints" highlighted, press **ENT**.
4. A "delete all waypoints" confirmation window is displayed. With "Yes?" highlighted, press **ENT** to delete all user waypoints from memory.

Section 7 NRST Pages

NRST Page Group

Section 2 introduced the GNC 420's main page groups—NAV, WPT, AUX, —and described each page in the NAV group. A fourth separate page group (NRST) provides detailed information for the nine nearest airports, VORs, NDBs, intersections and user waypoints within 200 nm of your current position. In addition, the NRST pages include the five nearest Flight Service Station (FSS) and center (ARTCC/FIR) points of communication, plus alerts you to any Special Use (SUA) or Controlled Airspace you may be in or near.

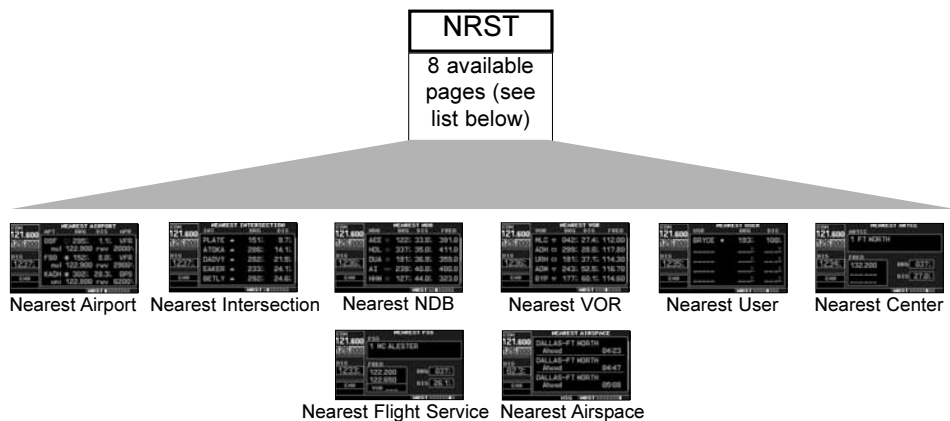

To quickly select a NRST page:

1. From any page, press **NRST** to select the Nearest Airport page. "NRST" will appear in the lower right corner of the screen.
2. Rotate the small right knob (**PUSH CRSR**) to select the desired NRST page.



NRST

1

COM		NEAREST AIRPORT			
		APT	BRG	DIS	APR
121.600	125.000	08F	295° _M	1.1 _m	VFR
		mul	122.900	rwy	2000'
		F80	152° _M	8.0 _m	VFR
		mul	122.900	rwy	2900'
		KADH	302° _M	28.3 _m	GPS
		uni	122.800	rwy	6200'

NRST 00000000

**PUSH
CRSR**

2

COM		NEAREST VOR			
		VOR	BRG	DIS	FREQ
121.600	125.000	MLC	042° _M	27.4 _m	112.00
		ADH	299° _M	28.8 _m	117.80
		URH	191° _M	37.1 _m	114.30
		ADM	243° _M	52.5 _m	116.70
		BYP	177° _M	60.1 _m	114.60

NRST 00000000

NRST PAGES

7 Scrolling Through Nearest Lists

3 a

NEAREST AIRPORT				
COH	APT	BRG	DIS	APR
119.100	4A0	120°	13.9 ⁿ _m	VFR
121.900	uni	122.800	rwy	3000'
DIS	KPOK	027°	15.5 ⁿ _m	ILS
---	twr	120.000	rwy	6000'
ENR	117	166°	15.8 ⁿ _m	GPS
---	uni	122.725	rwy	4500'

HSG NRST 000000

scroll bar

3 b

NEAREST FSS			
COH	FSS	BRG	DIS
119.100	1 MACON	229°	1.0 ⁿ _m
121.900			
DIS	FREQ		
---	122.100 TX		
---	116.900 RX		
ENR	VOR ATL		

HSG NRST 000000

3 b

NEAREST ARTCC			
COH	ARTCC	BRG	DIS
119.100	4 ATLANTA	008°	50.8 ⁿ _m
121.900			
DIS	FREQ		
---	121.350		
---	131.100		
ENR	134.800		

HSG NRST 000000

Not all nine nearest airports, VORs, NDBs, intersections or user waypoints can be displayed on the corresponding NRST page at one time. The *nearest airport page* displays detailed information for three nearest airports, with a scroll bar along the right-hand side of the page indicating which part of the list is currently being viewed. The *nearest airspace page* displays detailed information for up to three special use or controlled airspace alerts. The NRST pages for VORs, NDBs, intersections, and user waypoints will display five waypoints at a time. The flashing cursor and large right knob (⌂) are used to scroll and view the rest of the waypoints or airspaces in the list.

To scroll through the list of nearest airports, VORs, NDBs, intersections, user waypoints or airspace:

1. Select the desired NRST page, using the steps outlined on page 111.
2. Press the small right knob (PUSH CRSR) to activate the cursor.
- 3a. Rotate the large right knob (⌂) to scroll through the list. The scroll bar along the right-hand side of the page will indicate which part of the list is currently being viewed.
4. Press the small right knob (PUSH CRSR) to remove the flashing cursor.

The *nearest ARTCC* and *nearest FSS* pages present detailed information for up to five nearby facilities—displaying only one facility at a time. Again, the additional information is viewed using the flashing cursor and large right knob (⌂) to scroll through the list.

To scroll through the list of nearest flight service station or center points of communication:

1. Select the desired NRST page, using the steps outlined on page 111.
2. Press the small right knob (PUSH CRSR) to activate the cursor.
- 3b. Rotate the small right knob (PUSH CRSR) to scroll through the list.
4. Press the small right knob (PUSH CRSR) to remove the flashing cursor.

Navigating to a Nearby Waypoint

The NRST pages can be used in conjunction with the GNC 420's direct-to function to quickly set a course to a nearby facility. This feature can often be a real time saver compared to retrieving information from the database using the WPT pages. More importantly, it instantly provides navigation to the nearest airport in case of an in-flight emergency.

To select a nearby airport, VOR, NDB, intersection or user waypoint as a direct-to destination:

1. Use the flashing cursor to scroll through a NRST page list and highlight the desired nearest waypoint, as outlined on page 112.
2. Press **→** to display the select direct-to waypoint page.
3. Press **ENT** to accept the selected waypoint's identifier and press **ENT** a second time (with "Activate?" highlighted) to begin navigating to the selected waypoint.

Nearest Airport Page

The *nearest airport page* displays the identifier, symbol, bearing and distance to the nine nearest airports (within 200 nautical miles of your present position). For each airport listed, the *nearest airport page* also indicates the best available approach, common traffic advisory frequency (CTAF) and the length of the longest runway.

Airport Identifier,
Symbol, Bearing To
and Distance To

Tower or CTAF
Frequency and
Longest Runway

COM	NEAREST AIRPORT			
	APT	BRG	DIS	APR
122.800	51K	123°	6.8 _m	VFR
135.325	uni	122.700	2400 _{ft}	
	KLWC	270°	10.1 _m	ILS
	uni	123.000	5000 _{ft}	
	KIXD	149°	11.4 _m	ILS
	twr	118.300	7300 _{ft}	

Best Available
Approach

Scroll Bar

First Page
in NRST group

NRST PAGES

Nearest Airports

7

COM	NEAREST VOR			
	VOR	BRG	DIS	FREQ
119.100	ATL	214°	0.8 _m	116.90
121.900	PDK	028°	15.5 _m	116.60
	DOB	345°	17.7 _m	113.00
	RMG	316°	46.7 _m	115.40
	LGC	231°	52.9 _m	115.60

1

COM	SELECT → WAYPOINT	
119.100	PDK	SE USA
121.900	PEACHTREE	ATLANTA GA
	FPL 51K	NRST KATL
	N 33°52.54'	CRS 026°
	W084°17.93'	Activate?

2

COM	SELECT → WAYPOINT	
119.100	PDK	SE USA
121.900	PEACHTREE	ATLANTA GA
	FPL 51K	NRST KATL
	N 33°52.54'	CRS 026°
	W084°17.93'	Activate?

3

7

NRST PAGES

Nearest Airports



The *nearest airport page* can be configured to exclude shorter runways or undesirable runway surface types, so that the corresponding airports do not appear on the list. You may wish to use this feature to exclude seaplane bases or runway lengths which would be difficult or impossible to land upon. See page 145 for additional details.

The *nearest airport page* may be used to quickly tune the COM transceiver to a nearby airport. The selected frequency is placed in the standby field of the COM window and activated using the **C** key.

To quickly tune the common traffic advisory frequency (CTAF) from the nearest airport page:

1. Select the nearest airport page, using the steps outlined on page 111.
2. Press the small right knob (**PUSH CRSR**) to activate the cursor.
3. Rotate the large right knob (**⊖**) to scroll through the list, highlighting the COM frequency associated with the desired airport.
4. Press **ENT** to place the selected frequency in the standby field of the COM window.
5. Press **C** to activate the selected frequency.
6. Press the small right knob (**PUSH CRSR**) to remove the flashing cursor.

Additional communication frequencies, runway information and more is available from the *nearest airport page* by highlighting the identifier of the desired airport and pressing **ENT**.

To view additional information for a nearby airport:

1. Select the nearest airport page, using the steps outlined on page 111.
2. Press the small right knob (PUSH CLR) to activate the cursor.
3. Rotate the large right knob (PUSH CLR) to scroll through the list, highlighting the identifier of the desired airport.
4. Press ENT to display the airport location page for the selected airport.
5. To view additional WPT pages for the selected airport (including the airport runway and airport frequency pages) press the small right knob (PUSH CLR) to remove the flashing cursor. Rotate the small right knob (PUSH CLR) to display the additional WPT pages. When finished, press the small right knob (PUSH CLR) to return the flashing cursor to the screen.
6. To return to the nearest airport page, verify that "Done?" is highlighted by the flashing cursor and press ENT (or press CLR).

Nearest Intersection Page

The *nearest intersection page* displays the identifier, symbol, bearing and distance to the nearest intersections (within 200 miles of your present position).

To view additional information for a nearby intersection, start from the nearest intersection page and follow steps 2 through 4 above.

Nearest NDB Page

The *nearest NDB page* displays the identifier, symbol, bearing and distance to the nine nearest NDBs (within 200 nautical miles of your present position).

To view additional information for a nearby intersection, start from the nearest NDB page and follow steps 2 through 4 above.

Nearest VOR Page

The *nearest VOR page* displays the identifier, symbol, bearing and distance to the nine nearest VORs (within 200 nautical miles of your present position). For each VOR listed, the *nearest VOR page* also indicates the frequency of the nearby VOR for reference in tuning a VOR receiver.

NRST PAGES

Nearest VORs

7

COM	NEAREST AIRPORT			
	APT	BRG	DIS	APR
118.500	KATL	003°	0.0 ⁿ	ILS
119.100	twr	119.100	rwyt	11800%
DIS	KFTY	334°	9.6 ⁿ	ILS
	twr	118.500	rwyt	5700%
ENR	8A9	243°	12.3 ⁿ	VFR
	uni	123.000	rwyt	2600%
	HSG NRST 00000000			

3

COM	APT	KFTY	Public	Done?
118.500	FACILITY & CITY NAME			
119.100	FULTON CO BROWN			
	ATLANTA GA			
DIS	POSITION		ELEV	FUEL
	N 33°46.75'		840'	Avgas
	W084°31.29'			Jet
ENR	APR	ILS	RADAR	Yes
			ARSPC	B
	HSG NRST 00000000			

4

COM	APT	KFTY	Public	Done?
118.500	RUNWAY			
119.100	08-26			
DIS	INFO			5700%
	x100%			Hard Srfc
	Full Time			
ENR	1.5% over zoom			
	HSG NRST 00000000			

5

7

NRST PAGES

Nearest VORs

3

COH	NEAREST VOR			
	VOR	BRG	DIS	FREQ
118.500	ATL	214° _M	0.8 _n _M	116.90
119.100	PDK	028° _M	15.5 _n _M	116.60
DIS	003	345° _M	17.7 _n _M	113.00
	RMG	316° _M	46.7 _n _M	115.40
ENR	LGC	231° _M	52.9 _n _M	115.60
HSG NRST 00000000				

4

COH	VOR	Low Alt. Done?	
118.500	PDK	FACILITY, CITY & REGION	
119.100		PEACHTREE	
		ATLANTA GA	
		SE USA	VAR W002°
DIS		POSITION	FREQ
		N 33°52.54'	116.60
		W084°17.93'	
ENR		HSG HPT 0000000000	

VOR Identifier and Symbol

VOR Frequency

Bearing To and Distance To

Scroll Bar

Fourth Page in NRST group

COH	NEAREST VOR			
	VOR	BRG	DIS	FREQ
122.800	DJC	124° _M	15.6 _n _M	113.00
135.325	RIS	065° _M	20.2 _n _M	111.40
DIS	MKC	044° _M	25.4 _n _M	112.60
	TUP	284° _M	26.9 _n _M	117.80
ENR	FOE	260° _M	31.1 _n _M	111.60
HSG NRST 00000000				

To view additional information for a nearby VOR:

1. Select the nearest VOR page, using the steps outlined on page 111.
2. Press the small right knob (PUSH CRSR) to activate the cursor.
3. Rotate the large right knob (R) to scroll through the list, highlighting the identifier of the desired VOR.
4. Press ENT to display the VOR page for the selected VOR.
5. To return to the nearest VOR page, verify that "Done?" is highlighted by the flashing cursor and press ENT (or press CLR).
6. Press the small right knob (PUSH CRSR) to remove the flashing cursor.

NRST PAGES

Nearest ARTCC

7

Nearest User Waypoint Page

The *nearest user waypoint page* displays the identifier, symbol, bearing and distance to the nine nearest user waypoints (within 200 nautical miles of your present position).

Nearest Center (ARTCC) Page

The *nearest center page* displays the facility name, bearing to and distance to the five nearest ARTCC points of communication (within 200 nautical miles of your present position). For each ARTCC listed, the *nearest center page* also indicates the frequency(s) and may be used to quickly tune the COM transceiver to the center's frequency. The selected frequency is placed in the standby field of the COM window and activated using the **C** key.

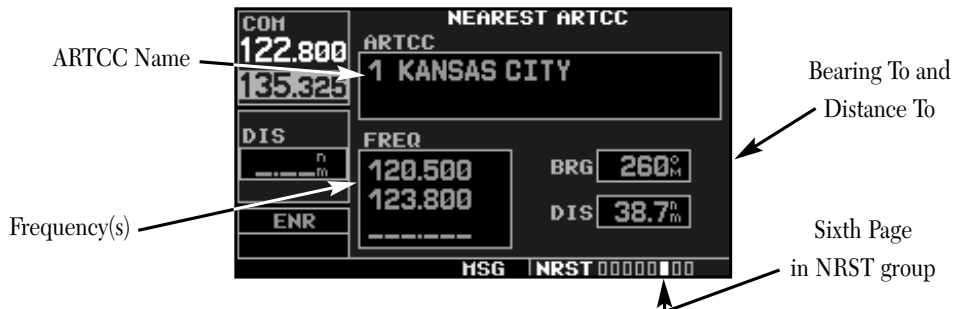

To quickly tune an ARTCC's frequency from the nearest center page:

1. Select the nearest center page, using the steps outlined on page 111.
2. Press the small right knob (**PUSH CRSR**) to activate the cursor.
3. Rotate the large right knob (**ENT**) to scroll through the list, selecting the desired ARTCC.
4. Rotate the large right knob (**ENT**) to scroll down the page, highlighting the desired frequency.
5. Press **ENT** to place the selected frequency in the standby field of the COM window.
6. Press **C** to activate the selected frequency.
7. Press the small right knob (**PUSH CRSR**) to remove the flashing cursor.

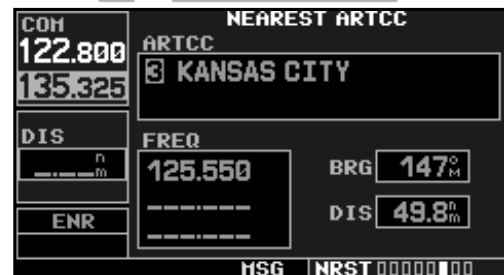

7

NRST PAGES

Nearest FSS





Nearest Flight Service Station (FSS) Page

The *nearest flight service station page* displays the facility name, bearing to and distance to the five nearest FSS points of communication (within 200 nautical miles of your present position). For each FSS listed, the *nearest flight service station page* also indicates the frequency(s) and may be used to quickly tune the COM transceiver to the FSS's frequency. The selected frequency is placed in the standby field of the COM window and activated using the  key.

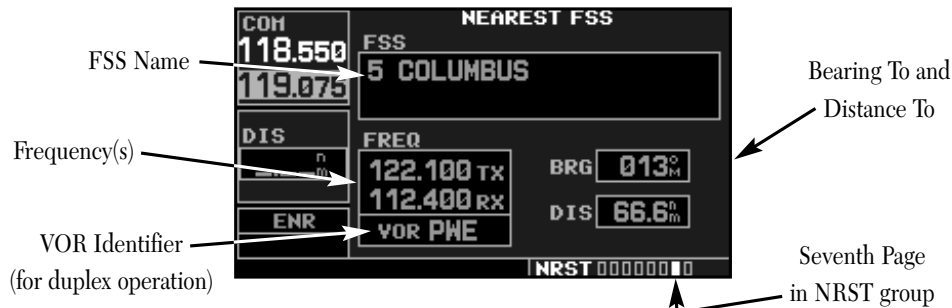
For duplex operations, “RX” and “TX” indications will appear beside the listed frequencies—indicating “receive only” or “transmit only” frequencies. The associated VOR is also provided for reference.



To quickly tune an FSS's frequency from the nearest flight service station page:

1. Select the nearest flight service station page, using the steps outlined on page 111.
2. Press the small right knob  to activate the cursor.
3. Rotate the small right knob  to scroll through the list, selecting the desired FSS.
4. Rotate the large right knob  to scroll down the page, highlighting the desired COM frequency.

{continued}

5. Press **ENT** to place the selected frequency in the standby field of the COM window.
6. Press **C** to activate the selected frequency.
7. Press the small right knob (**PUSH CRSB**) to remove the flashing cursor.

Nearest Airspace Page

The last page in the NRST group, the *nearest airspace page*, will alert you to as many as nine controlled or special use airspaces near or in your flight path. Alerts are provided according to the following conditions:

- If your projected course will take you inside an airspace within the next ten minutes, the alert message “**Airspace ahead -- less than 10 minutes**” will appear. The *nearest airspace page* will show the airspace as “**Ahead**”.
- If you are within two nautical miles of an airspace and your current course will take you inside, the message “**Airspace near and ahead**” will appear. The *nearest airspace page* will show “**Within 2nm of airspace**”.
- If you are within two nautical miles of an airspace and your current course will **not** take you inside, the message “**Near airspace less than 2nm**” will appear. The *nearest airspace page* will show the airspace as “**Ahead < 2nm**”.
- If you have entered an airspace, the message “**Inside Airspace**” will appear. The *nearest airspace page* will show “**Inside of airspace**”.

Note that the airspace alerts are based on three-dimensional data (latitude, longitude and altitude) to avoid nuisance alerts. The alert boundaries for controlled airspace are also sectorized to provide complete information on any nearby airspace. Once one of the described conditions exists, the message annunciator will flash, alerting you of an airspace message.

NRST PAGES

Nearest Airspaces

7



7

NRST PAGES

Nearest Airspaces



To view an airspace alert message:

- 1a. When the message annunciator above the **MSG** key flashes, press **MSG**.
2. Press **MSG** again to return to the previous page.

Once you have been provided an airspace alert message, detailed information concerning the specific airspace is provided on the *nearest airspace page*. The *nearest airspace page* displays the airspace name, status (“Ahead”, “Ahead < 2nm”, etc. as described on the previous page), and a time to entry (if applicable). By selecting any airspace name listed on the *nearest airspace page*, additional details will be provided—including controlling agency, communication frequencies and floor/ceiling limits.

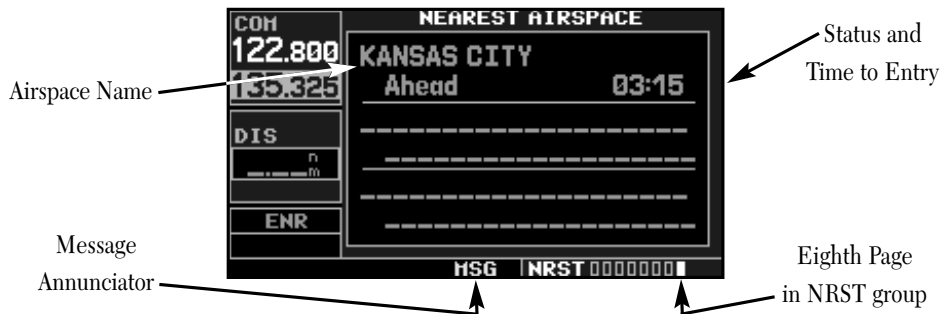

To view additional details for an airspace listed on the nearest airspace page:

- 1b. Select the nearest airspace page, using the steps outlined on page 111.
2. Press the small right knob (PUSH CRSR) to activate the cursor.
3. Rotate the large right knob (CRSR) to scroll through the list, highlighting the desired airspace.
4. Press **ENT** to display the airspace page for the selected nearby airspace.
5. To return to the nearest airspace page, verify that “Done?” is highlighted by the flashing cursor and press **ENT**.
6. Press the small right knob (PUSH CRSR) to remove the flashing cursor.

NRST PAGES 7

Nearest Airspaces

Airspace Name and Type →

Status and Time to Entry →

“Done?” Field (return to previous page) ←

“Frequencies?” Field (display frequency page) ←

Floor/Ceiling Limits ←

To view and quickly tune the frequency for a controlling agency:

1. Follow steps #1 through #4 on the previous page to display the airspace page for the desired controlled or special use airspace.
2. Rotate the large right knob (⌚) to highlight “Frequencies?” and press **ENT**.
3. Rotate the large right knob (⌚) to scroll through the list, highlighting the desired frequency.
4. Press **ENT** to place the selected frequency in the standby field of the COM window.
5. Press **C** to activate the selected frequency.
6. To return to the airspace page, rotate the large right knob (⌚) to highlight “Done?” and press **ENT** (or press **CLR**).
7. To return to the nearest airspace page, rotate the large right knob (⌚) to highlight “Done?” and press **ENT** (or press **CLR**).
8. Press the small right knob (⌚) to remove the flashing cursor.

②

③

④

7

NRST PAGES

Nearest Airspaces

COH 124.900 119.100	CLASS C TULSA	Done?
DIS	CONTROLLING AGENCY TULSA APP	
ENR	STATUS Inside	Frequencies? VERT LIMITS 4700' msl Surface
HSG NRST 00000000		

COH 126.200 122.800	MOA CAMPBELL ONE	Done?
DIS	CONTROLLING AGENCY FAA MEMPHIS ARTCC	
ENR	STATUS Inside	Frequencies? VERT LIMITS 10000' msl 500' agl
HSG NRST 00000000		

COH 126.200 122.800	PROHIBITED AREA P-56	Done?
DIS	CONTROLLING AGENCY -----	
ENR	STATUS Ahead < 2nm 00:52	Frequencies? VERT LIMITS 18000' msl Surface
HSG NRST 00000000		

The *airspace page* displays (and airspace alert messages are provided for) the following airspace types:

- Alert
- Class B
- CTA
- MOA
- Restricted
- Training
- Unspecified
- Caution
- Class C
- Danger
- Prohibited
- TMA
- TRSA
- Warning

The bottom right-hand corner of the *airspace page* displays the floor and ceiling limits of the airspace. The following are examples of what may appear as vertical limits for an airspace:

- 5000' msl (5000 feet mean sea level)
- 5000' agl (5000 feet above ground level)
- MSL (at mean sea level)
- Notam (see Notice to Airmen)
- Unknown
- See Chart
- Unlimited
- Surface

All airspace alert messages, except for prohibited areas, may be turned on or off from the *airspace alarms page*. An altitude buffer is also provided on the *airspace alarms page* to provide an extra margin of safety above/below the published limits. See page 138 for additional details.

Section 8

AUX Pages

AUX Page Group

Section 2 introduced the GNC 420's main page groups—NAV, WPT, AUX—and described each page in the NAV group. The third page group (AUX) allows you to change unit settings, customizing operation to your preferences. The AUX pages also provide E6B functions—such as trip planning, fuel planning, density altitude, true airspeed and winds aloft calculations.

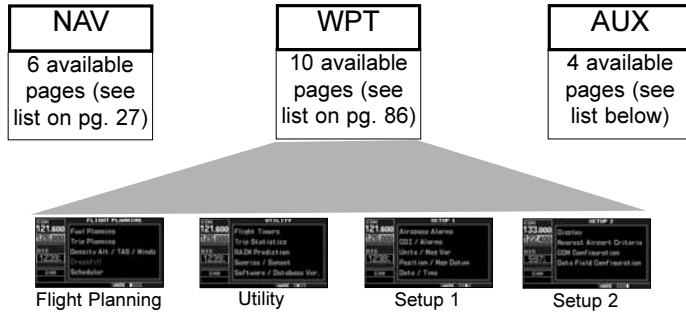

To quickly select an AUX page:

1. From any page, press and hold **CLR** to select the default NAV page. (You may skip this step if you are already viewing any of the main pages. See page 27.)
2. Rotate the large right knob (⊖) to select the AUX page group. "AUX" will appear in the lower right corner of the screen.
3. Rotate the small right knob (⊖) to select the desired AUX page.

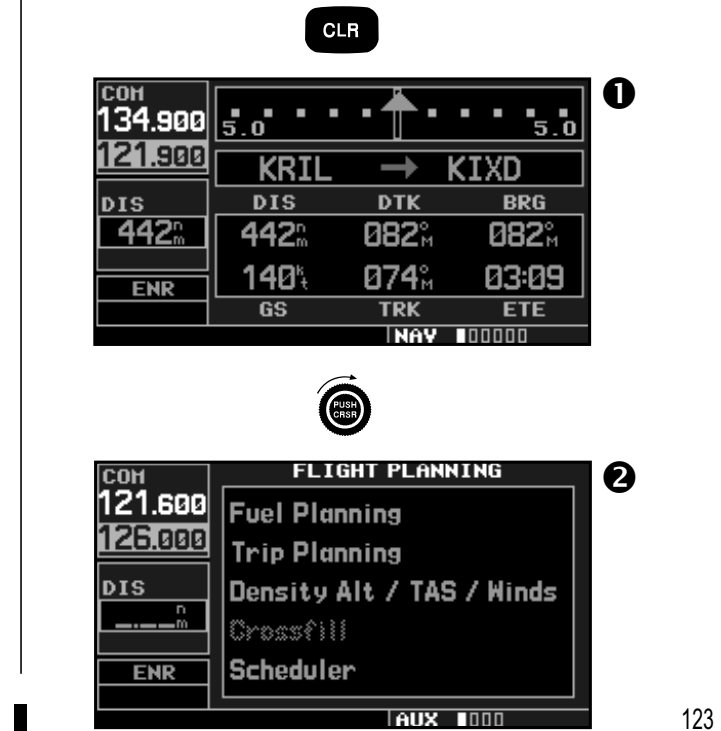

8

AUX PAGES Flight Planning

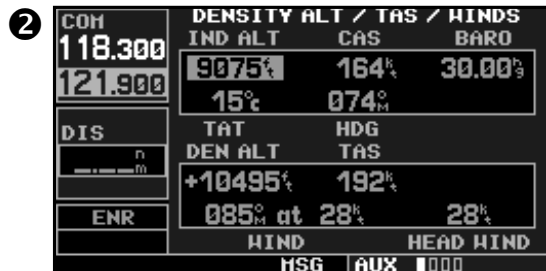

Flight Planning Page

Menu Options: to select, highlight with cursor and press **ENT**.



First Page
in AUX group

The *flight planning page* provides access (via “menu options”) to E6B functions for fuel planning, trip planning, density altitude/true airspeed/winds aloft calculations and a “Crossfill” function to transfer flight plans/user waypoints to a second 400/420/430 unit. When a menu option is selected, the corresponding page will appear providing additional information and features.

To select a menu option from the flight planning page:

1. Press the small right knob (PUSH CRN) momentarily, to activate the flashing cursor.
2. Rotate the large right knob (R) to select the desired menu option, and press **ENT**.

The following menu options are available:

Fuel Planning— when equipped with fuel flow (FF) and/or fuel on board (FOB) sensors, this option displays current fuel conditions along the active direct-to or flight plan. You may also manually enter fuel flow, ground speed (GS) and (in some instances) fuel on board figures for planning purposes. Fuel planning figures can be displayed not only for the currently active flight plan or direct-to, but also point-to-point between two specified waypoints and for any programmed flight plan.

Trip Planning— allows the pilot to view desired track (DTK), distance (DIS), estimated time en route (ETE), enroute safe altitude (ESA) and estimated time of arrival (ETA) information for a direct-to, point-to-point between two specified waypoints or for any programmed flight plan.

NOTE

Point-to-point waypoints, flight plans and/or ground speed (default is current GPS-calculated ground speed) entered on the fuel planning page will automatically transfer to the trip planning page, and vice versa.

Density Alt / TAS / Winds— indicates the theoretical altitude at which your aircraft will perform depending upon several environmental conditions, including indicated altitude (IND ALT), barometric pressure (BARO) and total air temperature (TAT; the temperature, including the heating effect of speed, read on a standard outside temperature gauge). This menu option computes true airspeed (TAS), based upon the factors above and the calibrated airspeed (CAS). Also, this menu option determines winds aloft—the wind direction and speed—and a head wind/tail wind component, based upon the calculated density altitude (DEN ALT), true airspeed, aircraft heading (HDG) and ground speed.

Crossfill— allows the pilot to transfer the active flight plan, any stored flight plan, a user waypoint or all user waypoints between two 400-Series GARMIN units (GNS 430/GNC 420/GPS 400) in a dual-unit installation.

Scheduler— displays reminder messages (such as “Change oil”, “Switch fuel tanks”, “Overhaul”, etc.) after a specified time or date has elapsed. For example, if you enter “Change oil” to be displayed in 30 hours, the message “Change oil” will be displayed after the GNC 420 has been operating for a total of 30 hours. After appearing, the message will be displayed each time the GNC 420 is turned on until it is changed or deleted.

AUX PAGES

Flight Planning

8

FUEL PLANNING			
COH	FPL LEG		
133.000	01	Cum	KPHX → KCOS
122.400	0?	0.0?	200%
DIS	FOB	FLOW	GS
478 _m	REQ	LFOB	LRES
ENR	0.0?	0.0?	00:00
	0.0	0.00 _m	00:00
	EFF	RNG	ENDUR
	AUX 0000		

2

FUEL PLANNING			
COH	FPL LEG		
133.000	01	Cum	KPHX → KCOS
122.400	0?	0.0?	200%
DIS	FOB	FLOW	GS
478 _m	REQ	LFOB	LRES
ENR	0.0	0.00 _m	00:00
	EFF	RNG	ENDUR
	AUX 0000		

PAGE MENU
Point to Point?
Change Fields?

2

The “Change Fields?” option above is only available on GNC 420 installations which include a Shadin fuel computer. In these installations, use the “Change Fields?” option to review separate fuel information for left and right engines.

8

AUX PAGES

Flight Planning

3 a

FUEL PLANNING			
POINT TO POINT			
COH	KABQ → KOKC		
118.300	0 ^g	0.0 ^g	164 ^h
121.900			
DIS	FOB	FF	GS
	REQ	LFOB	LRES
	0.0 ^g	0.0 ^g	00:00
ENR	0.0	0.00 ^m	00:00
	EFF	RNG	ENDUR
	HSG AUX 0000		

3 b

FUEL PLANNING			
FPL LEG			
COH	KABQ → KOKC		
118.300	00	02	164 ^h
121.900			
DIS	FOB	FF	GS
	REQ	LFOB	LRES
	0.0 ^g	0.0 ^g	00:00
ENR	0.0	0.00 ^m	00:00
	EFF	RNG	ENDUR
	HSG AUX 0000		

8

FUEL PLANNING			
FPL LEG			
COH	KABQ → KOKC		
118.300	88 ^g	12.5 ^g	162 ^h
121.900			
DIS	FOB	FF	GS
	REQ	LFOB	LRES
	32.5 ^g	55.4 ^g	04:26
ENR	13.0	1139 ^m	07:02
	EFF	RNG	ENDUR
	HSG AUX 0000		

Flight Planning Page: Fuel Planning

To perform fuel planning operations:

1. Select "Fuel Planning" from the flight planning page, using the steps described on page 124.
2. The current fuel planning "leg mode" is displayed at the top of the page: "POINT TO POINT" or "FPL LEG" (for a flight plan leg). To change the leg mode, press **MENU** to display an options window for the other leg mode, then press **ENT** to accept the other leg mode.
- 3a. For point-to-point fuel planning, rotate the small **(PUSH CRSR)** and large **(PUSH CRSR)** right knobs to enter the identifier of the "from" waypoint. Once the waypoint's identifier is entered, press **ENT** to accept the waypoint. The flashing cursor moves to the "to" waypoint. Again, rotate the small **(PUSH CRSR)** and large **(PUSH CRSR)** right knobs to enter the identifier of the "to" waypoint and press **ENT** to accept the waypoint. **OR**,
- 3b. For "flight plan leg" fuel planning, rotate the small right knob **(PUSH CRSR)** to select the desired flight plan (already stored in memory), by number. Rotate the large right knob **(PUSH CRSR)** to highlight the "LEG" field and rotate the small right knob **(PUSH CRSR)** to select the desired leg of the flight plan, or select "Cum" to apply fuel planning calculations to the entire flight plan.
4. Rotate the large right knob **(PUSH CRSR)** to highlight the fuel on board (FOB) field.
5. Use the small **(PUSH CRSR)** and large **(PUSH CRSR)** right knobs to enter the amount of fuel on board. Press **ENT** when finished.
6. The flashing cursor moves to the fuel flow (FF) field. Use the small **(PUSH CRSR)** and large **(PUSH CRSR)** right knobs to enter the fuel flow rate. Press **ENT** when finished.
7. The flashing cursor moves to the ground speed (GS) field. Use the small **(PUSH CRSR)** and large **(PUSH CRSR)** right knobs to enter the ground speed. Press **ENT** when finished.
8. With all variables entered, the following information will be provided:

- REQ— Quantity of fuel required
- LFOB— Left-over fuel on board
- LRES— Left-over fuel reserve time
- EFF— Efficiency, expressed in distance per fuel units (e.g. nautical miles per gallon)
- RNG— Range (distance)
- ENDUR— Flight endurance, or total available flight time

Flight Planning Page: Fuel Planning (cont.)

- To reconfigure the data fields, press **MENU** to display the options window. Rotate the small right knob (PUSH CHG) to highlight the "Change Fields?" option. Press **ENT** to reconfigure the data fields. Rotate the large right knob (PUSH CHG) to select the desired field. Rotate the small right knob (PUSH CHG) to highlight the desired data. Press **ENT** to select the data

Fuel Planning figures can be entered and displayed based upon one of three possible configurations:

- 1) No fuel sensors connected - In this instance fuel flow is manually entered and is used to calculate fuel on board. When fuel flow or fuel on board is manually entered, the figures are retained the next time you view the page (with fuel on board continuously calculated).*
- 2) Fuel flow sensor installed, but no fuel on board sensor - Fuel on board is manually entered. Fuel flow is automatically provided by the sensor. If fuel flow is manually entered (to override the sensor), it will not affect the FOB figure and is not retained the next time you view the page.*
- 3) Fuel flow and fuel on board sensors installed - Fuel flow and fuel on board are automatically provided by sensors. Fuel on board can NOT be entered manually. Fuel flow can be entered manually, but will not affect the FOB figure and is not retained the next time you view the page.*

NOTE

AUX PAGES

Flight Planning

8

8

AUX PAGES

Flight Planning

3 a

COH 118.300 121.900		TRIP PLANNING POINT TO POINT	
DIS		KABQ → KOKC	
ENR		19:24 _z	162 _k
DEP TIME		GS	
DTK		DIS	ETE
074°		443 _m	02:44
15500 _{ft}		22:08 _z	
ESA		ETA	
MSG AUX 000			

3 b

COH 118.300 121.900		TRIP PLANNING FPL LEG	
DIS		00 02 KABQ → KOKC	
ENR		19:24 _z	162 _k
DEP TIME		GS	
DTK		DIS	ETE
074°		443 _m	02:44
15500 _{ft}		23:54 _z	
ESA		ETA	
MSG AUX 000			

7

COH 118.300 121.900		TRIP PLANNING FPL LEG	
DIS		00 02 KABQ → KOKC	
ENR		19:30 _z	162 _k
DEP TIME		GS	
DTK		DIS	ETE
074°		443 _m	02:44
15500 _{ft}		00:00 _z	
ESA		ETA	
MSG AUX 000			





Flight Planning Page: Trip Planning

To perform trip planning operations:

1. Select "Trip Planning" from the flight planning page, using the steps described on page 122.
2. The current trip planning "leg mode" is displayed at the top of the page: "POINT TO POINT" or "FPL LEG" (for a flight plan leg). To change the leg mode, press **MENU** to display an options window for the other leg mode, then press **ENT** to accept the other leg mode.
- 3a. For point-to-point trip planning, rotate the small **(PUSH CRSEL)** and large **(SEL)** right knobs to enter the identifier of the "from" waypoint. Once the waypoint's identifier is entered, press **ENT** to accept the waypoint. The flashing cursor moves to the "to" waypoint. Again, rotate the small **(PUSH CRSEL)** and large **(SEL)** right knobs to enter the identifier of the "to" waypoint and press **ENT** to accept the waypoint. **OR**,
- 3b. For "flight plan leg" trip planning, rotate the small right knob **(PUSH CRSEL)** to select the desired flight plan (already stored in memory), by number. Rotate the large right knob **(SEL)** to highlight the "LEG" field and rotate the small right knob **(PUSH CRSEL)** to select the desired leg of the flight plan, or select "Cum" to apply trip planning calculations to the entire flight plan.
4. Rotate the large right knob **(SEL)** to highlight the departure time (DEP TIME) field.
5. Use the small **(PUSH CRSEL)** and large **(SEL)** right knobs to enter the departure time. Press **ENT** when finished. (Departure time may be entered in local or UTC time, depending upon unit settings. See page 141.)
6. The flashing cursor moves to the ground speed (GS) field. Use the small **(PUSH CRSEL)** and large **(SEL)** right knobs to enter the ground speed. Press **ENT** when finished.
7. With all variables entered, the following information will be provided:
 - DTK— Desired track, or desired course
 - DIS— Distance
 - ETE— Estimated time en route
 - ESA— En route safe altitude
 - ETA— Estimated time of arrival

Flight Planning Page: Density Alt / TAS / Winds

To calculate density altitude, true airspeed, winds aloft:

1. Select "Density Alt / TAS / Winds" from the flight planning page, using the steps described on page 124.
2. The flashing cursor highlights the indicated altitude (IND ALT) field. Use the small and large (⊖) right knobs to enter the altitude indicated on your altimeter. Press  when finished.
3. The flashing cursor moves to the calibrated airspeed (CAS) field. Use the small and large (⊖) right knobs to enter the airspeed from your airspeed indicator. Press  when finished.
4. The flashing cursor moves to the barometric pressure (BARO) field. Use the small and large (⊖) right knobs to enter the barometric pressure (altimeter setting). Press  when finished.
5. The flashing cursor moves to the total air temperature (TAT) field. Use the small and large (⊖) right knobs to enter the temperature. Press  when finished.
6. The flashing cursor moves to the aircraft heading (HDG) field. Use the small and large (⊖) right knobs to enter the aircraft heading from the directional gyro or compass. Press  when finished.
7. With all variables entered, the following information will be provided:
 - DEN ALT— Density altitude
 - TAS— True airspeed
 - WIND— Wind direction and speed
 - HEAD/TAIL WIND—Magnitude of head wind or tail wind component

NOTE

If your installation includes components (such as an airdata sensor) to provide any of the variables above, the density alt/tas/winds page data will default to the values provided by these components.

AUX PAGES Flight Planning

8

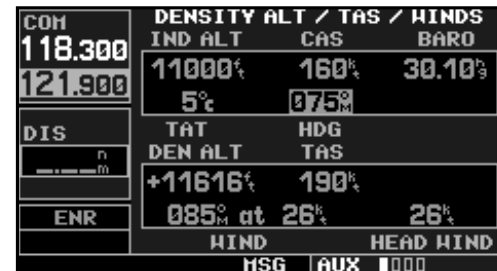
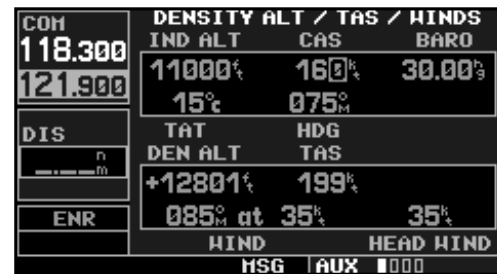

8

AUX PAGES

Flight Planning

1

CROSSFILL	
COH 118.000 136.975	METHOD STATUS Auto Not Avail
DIS n m	TRANSFER Active Flight Plan
ENR	To CROSS-SIDE
Initiate Transfer?	
MSG AUX 0000	

2

CROSSFILL	
COH 118.000 136.975	METHOD STATUS Auto Not Avail
DIS n m	TRANSFER Active Flight Plan
ENR	To CROSS-SIDE
Initiate Transfer?	
MSG AUX 0000	

TRANSFER
Flight Plan
User Waypoints (all)

5

CROSSFILL	
COH 118.000 136.975	METHOD STATUS Auto Ready
DIS n m	TRANSFER Active Flight Plan
ENR	To CROSS-SIDE
Initiate Transfer?	
MSG NAV 000000	

Flight Planning Page: Crossfill

To transfer flight plans or user waypoints to/from a second 400-Series unit:

1. Select "Crossfill" from the flight planning page, using the steps described on page 124.
2. The flashing cursor highlights the method field. Rotate the small right knob (PUSH OPEN) to select "Auto" or "Manual". "Auto" will automatically transfer any section of (or any change to) a direct-to destination or active flight plan to a second 400- or 500-series GARMIN unit.
3. The flashing cursor highlights the transfer data option (TRANSFER) field. Rotate the small right knob (PUSH OPEN) to display a window of available data options:
 - **Active Flight Plan**—transfer the active flight plan to/from a second 400-Series GARMIN unit (GNS 430/GNC 420/GPS 400) in a dual unit installation. This option is the default when selecting "Crossfill" from the *flight planning page*.
 - **Flight Plan**—transfer any stored flight plan to/from a second 400-Series unit, by selecting the flight plan by number. This option is the default when selecting "Crossfill" from the *flight plan catalog*. See page 56.
 - **User Waypoints (all)**—transfer all stored user waypoints to/from a second 400-Series unit.
 - **User Waypoint**—transfer the specified user waypoint to a second 400-Series unit.
4. Continue rotating the small right knob (PUSH OPEN) to select the desired data option. Press ENT when finished.
5. For a stored flight plan ("Flight Plan" data option), the flight plan number field is highlighted. Rotate the small right knob (PUSH OPEN) to select the desired flight plan and press ENT.
6. For a specified user waypoint ("User Waypoint" data option), the waypoint identifier field is highlighted. Use the small (PUSH OPEN) and large (PUSH OPEN) right knobs to enter the identifier of the desired user waypoint. Press ENT when finished.
7. The flashing cursor moves to the "CROSS-SIDE" field. Rotate the small right knob (PUSH OPEN) to select "To" or "From" and press ENT.
8. The flashing cursor moves to the "Initiate Transfer?" confirmation field. Press ENT to transfer the selected data.

Flight Planning Page: Scheduler

To enter a scheduled message:

1. Select "Scheduler" from the flight planning page, using the steps described on page 122.
2. The flashing cursor highlights the first message field. If necessary, rotate the large right knob (⊖) to highlight the first blank message field.
- 3a. Use the small (⊖) and large (⊖) right knobs to enter the message text. Press **ENT** when finished. (The GNC 420 will store up to nine scheduled messages holding 20 characters each.)
4. The flashing cursor moves to the type field under the new message. Rotate the small right knob (⊖) to display a window of available options: (Event, One Time, Periodic). Press **ENT** to select.
5. The flashing cursor moves to the time/date field. Use the small (⊖) and large (⊖) right knobs to set the elapsed time or date required before the message is displayed. Time is entered as hours/minutes/seconds (hhh:mm:ss). Event-based messages expire at a specific date and time. Press **ENT** when finished.

To edit a scheduled message:

1. Select "Scheduler" from the flight planning page, using the steps described on page 128.
2. The flashing cursor highlights the first message field.
- 3b. To edit the message text, rotate the large right knob (⊖) to highlight the desired message field. Use the small (⊖) and large (⊖) right knobs to edit the message text—entering the new text directly over the old message. Press **ENT** when finished.
4. To edit the time field, rotate the large right knob (⊖) to highlight the field. Use the small (⊖) and large (⊖) right knobs to edit the new date or elapsed time—entering the new time directly over the old figure. Press **ENT** when finished.

To delete a scheduled message:

1. Select "Scheduler" from the flight planning page, using the steps described on page 128.
2. The flashing cursor highlights the first message field. Rotate the large right knob (⊖) to highlight the desired message field.
- 3c. Press **CLR** to delete the message text, followed by **ENT** to confirm the deletion.

AUX PAGES

Flight Planning

8

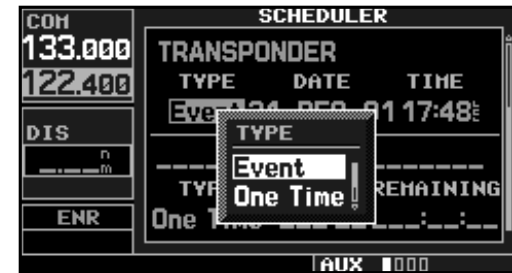

8

AUX PAGES

Utility Page

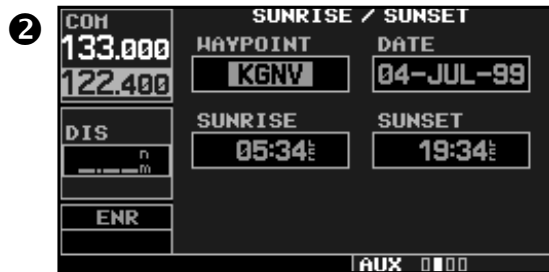
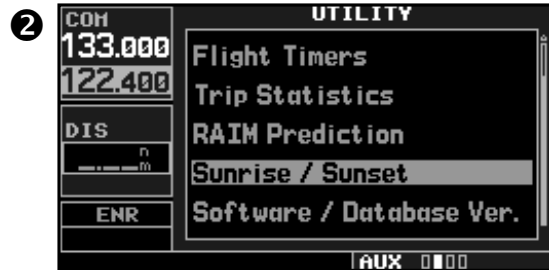
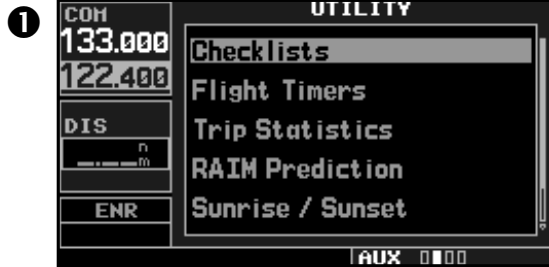

Utility Page

Menu Options: to select, highlight with cursor and press **ENT**.

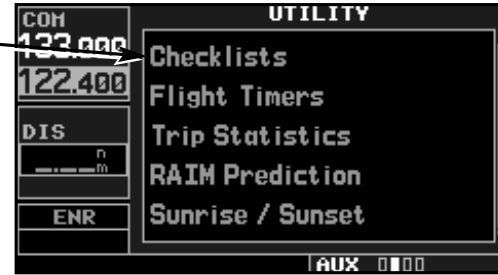

Second Page in AUX group

The *utility page* provides access (via “menu options”) to checklists, a count down/up timer, trip timers, trip statistics, RAIM (Receiver Autonomous Integrity Monitoring) prediction, sunrise/sunset time calculations and software/database version information. When a menu option is selected, the corresponding page will appear providing additional information and features.

To select a menu option from the utility page:

1. Press the small right knob (PUSH) momentarily, to activate the flashing cursor.
2. Rotate the large right knob (ENT) to select the desired menu option, and press **ENT**.

The following menu options are available:

Checklists— provides up to nine different user-defined checklists containing up to 30 items each of sixteen character lines.

Flight Timers— provides count up/down timers, plus automatic recording of departure time and total trip time. Departure and total trip time recording can be configured to run either any time GNC 420 power is on, or only when your ground speed exceeds 30 knots.

Trip Statistics— provides readouts for trip odometers, average speed and maximum speed. These readouts are resettable (individually or all at once) by pressing **MENU** to display an options window.

RAIM Prediction— allows you to confirm that GPS coverage is available for your current location or at a specified waypoint at any time and date. Receiver Autonomous Integrity Monitoring performs checks to ensure that the GNC 420 will have adequate satellite geometry to work with during your flight. RAIM availability will be near 100% in Oceanic, En route and Terminal phases of flight. Because the FAA's TSO requirements for non-precision approaches specify significantly better satellite coverage than other flight phases, RAIM may not be available when flying some approaches. The GNC 420 will automatically monitor RAIM during approach operations and warn you if RAIM is not available. In such cases, use an external VLOC receiver instead for many of the non-precision approaches stored on your Jeppesen NavData® card. RAIM prediction will help you plan for a pending flight to confirm GPS operation during an approach.

Sunrise / Sunset— allows you to calculate the time of sunrise and sunset at any waypoint or your present position for a specified date.

Software / Database Ver.— provides software version information for the operating software within the GPS receiver, COM transceiver and main processor board. The *software / database version page* also displays the current Jeppesen database type and expiration date, along with the version and type of built-in land database.

Utility Page: Checklists

To create a checklist:

- 1a. Select "Checklist" from the utility page, using the steps described on page 129. Press **ENT** to display a list of checklists.
2. Press **MENU** to display an options menu. Rotate the large right knob (⊖) to select "Create New Checklist?" and press **ENT**.
3. Use the small (PUSH CRSH) and large (⊖) right knobs to enter the name of a checklist. Press **ENT** when finished. (Up to nine different checklists can be created and stored in the GNC 420.)
4. Use the small (PUSH CRSH) and large (⊖) right knobs to enter each checklist item followed each time by **ENT**. (Each checklist may contain up to 30 line items of as much as sixteen characters long.)

AUX PAGES

Utility Page

8

ENR

INTEG

An 'INTEG' annunciation at the bottom left corner of the screen indicates that satellite coverage is insufficient to pass built-in receiver autonomous integrity monitoring (RAIM) tests. When this occurs, the GPS receiver will continue to provide navigation information, but should not be used for primary navigation guidance.

If a 'WARN' annunciation appears at the bottom left corner, GPS satellite coverage may be sufficient, but the GNC 420 has detected a position error which exceeds protection limits. In this condition, all GPS navigation data on the GNC 420 will be disabled. When either 'INTEG' or 'WARN' annunciation are shown, use an alternate navigation source.

8

AUX PAGES

Utility Page

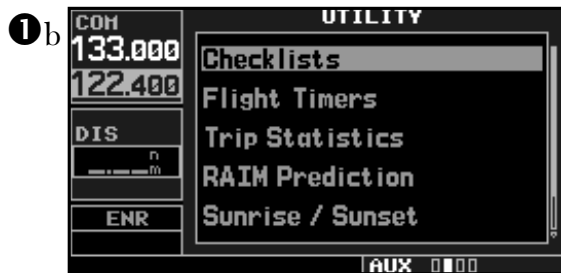

To execute a checklist:

- 1b. With the checklists page displayed, rotate the large right knob (⊖) to select the desired checklist and press **ENT**.
- 2b. As you complete each checklist item, press **ENT** to move to the next item on the list.

To edit a checklist:

1. With the checklists page displayed, rotate the large right knob (⊖) to select the desired checklist and press **ENT**.
2. Press **MENU** to display an options menu. Select "edit item" and press **ENT**, then use the small (⊖) and large (⊖) right knobs to edit each checklist item. Press **ENT** when finished.

To insert a checklist step into an existing checklist:

1. With the checklists page displayed, rotate the large right knob (⊖) to select the desired checklist and press **ENT**.
2. Rotate the large right knob (⊖) to highlight the existing checklist entry which will immediately follow the new checklist step.
3. Rotate the small (⊖) and large (⊖) right knobs to enter the new checklist step. Press **ENT** when finished.

To delete a checklist or all checklists:

1. With the checklists page displayed, press **MENU** to display an options menu.
2. Rotate the large right knob (⊖) to select "delete checklist" or "delete all checklists" and press **ENT** to remove the checklist or all checklists from memory.

To copy a checklist:

1. With the checklists page displayed and the desired checklist selected, press **MENU**.
2. Rotate the large right knob (⊖) to select "Copy Checklist?" and press **ENT** to copy the checklist to an empty checklist memory location.

To sort the checklists by name or entry:

1. With the checklists page displayed, press **MENU** to display an options menu.
2. Rotate the large right knob to select "Sort List By Entry?" or "Sort List By Name?" and press **ENT**.

Utility Page: Flight Timers

To view, use or reset the generic timer:

1. Select "Flight Timers" from the utility page, using the steps described on page 131.
2. The flashing cursor highlights "Start?". To start the generic timer, press **ENT**. (You will typically begin with this step for count up timers. However, for count down timers, you may wish to enter a count direction and time before starting the timer. See below.)
- 3a. To change the count direction, rotate the large right knob (⊖) to highlight count direction field: "Down" or "Up". Rotate the small right knob (⊕) to select the desired count direction. Press **ENT** when finished.
4. For a count down timer, rotate the large right knob (⊖) to highlight the time field. Use the small (⊕) and large (⊖) right knobs to enter the count down time—in hours, minutes and seconds. Press **ENT** when finished.
5. To stop the generic timer, rotate the large right knob (⊖) to highlight "Stop?" and press **ENT**.
6. To reset the generic timer, rotate the large right knob (⊖) to highlight the time field. Press **CLR**, followed by **ENT**.

To record or reset the departure time:

1. Select "Flight Timers" from the utility page, using the steps described on page 131.
2. Rotate the large right knob (⊖) to highlight the reset mode field, under "Departure Time". (The reset mode field will indicate "Pwr-on" or "GS>30kt".)
- 3b. Rotate the small right knob (⊕) to select the desired reset mode. ("Pwr-on" will record a departure time when the GNC 420 is turned on. "GS>30kt" will record a departure time once the GPS-computed ground speed exceeds 30 knots.)
4. Press **ENT** when finished.
5. To reset the departure time, rotate the large right knob (⊖) to highlight "Reset?" and press **ENT**.

AUX PAGES

Utility Page

8

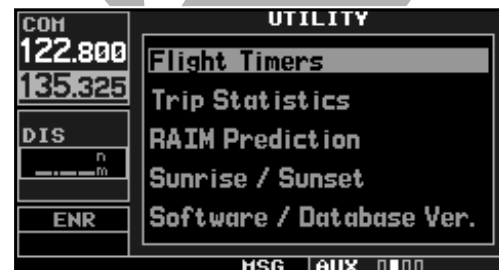

8

AUX PAGES

Utility Page

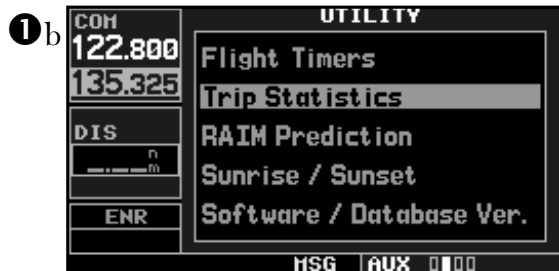

Utility Page: Flight Timers (cont.)

To view, use or reset total trip time:

- 1a. Select "Flight Timers" from the utility page, using the steps described on page 131.
- 2a. Rotate the large right knob (⊖) to highlight the reset mode field, under "Total Trip Time". (The reset mode field will indicate "Pwr-on" or "GS>30kt".)
3. Rotate the small right knob (⊖) to select the desired reset mode. ("Pwr-on" will record trip time, in hours/minutes/seconds, any time the GNC 420 is turned on. "GS>30kt" will record trip time any time the GPS-computed ground speed exceeds 30 knots.)
4. Press **ENT** when finished.
5. To reset the total trip time, rotate the large right knob (⊖) to highlight "Reset?" and press **ENT**.

Utility Page: Trip Statistics

To reset trip statistics readouts:

- 1b. Select "Trip Statistics" from the utility page, using the steps described on page 131.
- 2b. Press **MENU** to display an options window with several reset options:
 - **Reset Trip?**— Resets trip odometer and average ground speed readouts
 - **Reset Max Speed?**—Resets maximum speed readout only
 - **Reset Odometer?**— Resets odometer readout only
 - **Reset All?**— Resets all trip statistics readouts
3. Rotate the large right knob (⊖) to select the desired reset option and press **ENT**.

Utility Page: RAIM Prediction

To predict RAIM availability:

1. Select "RAIM Prediction" from the utility page, using the steps described on page 131.
2. The flashing cursor highlights the waypoint field. Use the small (PUSH CRSB) and large (PUSH CRSL) right knobs to enter the identifier of the waypoint at which you wish to determine RAIM availability. Press (ENT) when finished. (To determine RAIM availability for your present position, press (CLR), followed by (ENT).)
3. The flashing cursor moves to the arrival date field. Use the small (PUSH CRSB) and large (PUSH CRSL) right knobs to enter the date for which you wish to determine RAIM availability. Press (ENT) when finished.
4. The flashing cursor moves to the arrival time field. Use the small (PUSH CRSB) and large (PUSH CRSL) right knobs to enter the time for which you wish to determine RAIM availability. Press (ENT) when finished.
5. The flashing cursor moves to "Compute RAIM?". Press (ENT) to begin RAIM prediction. Once calculations are complete, the GNC 420 will display one of the following in the RAIM status field:

- **RAIM Not Available**— Satellite coverage is predicted to NOT be sufficient for reliable operation during non-precision approaches
- **RAIM Available**— Satellite coverage is predicted to be sufficient for reliable operation during all flight phases, including non-precision approaches

NOTE

RAIM computations predict satellite coverage within +/- 15 minutes of the specified arrival date and time. Refer to page 137 for specific information regarding RAIM protection limits.

AUX PAGES

Utility Page

8

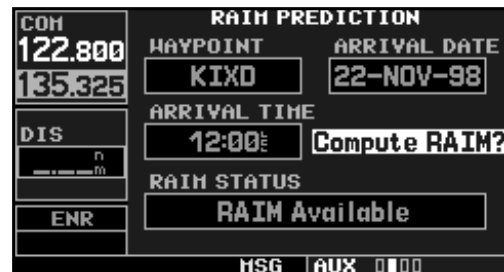
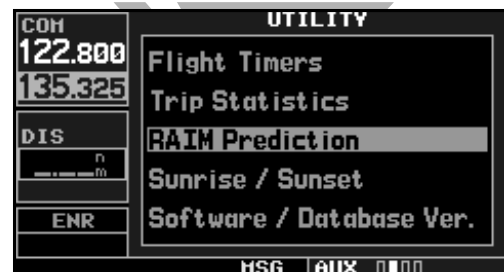

8

AUX PAGES

Utility Page

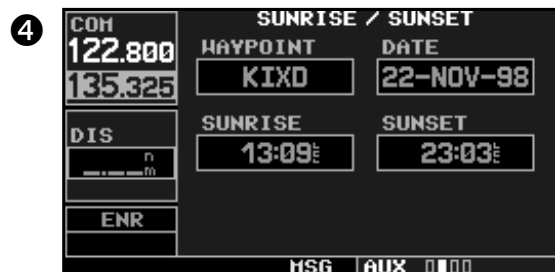
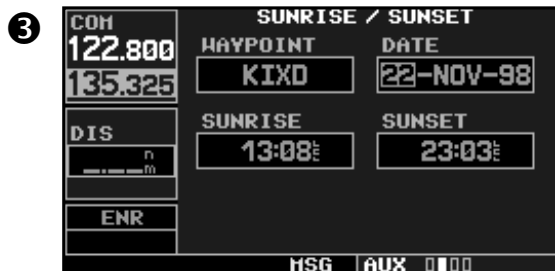
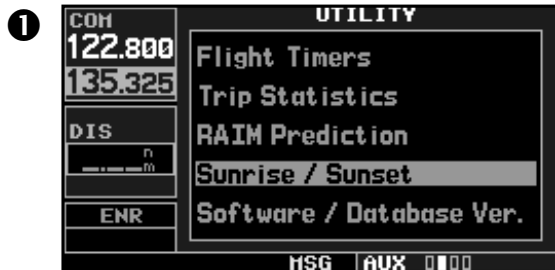

Utility Page: Sunrise / Sunset

To calculate sunrise and sunset times at any waypoint or your present position:

1. Select "Sunrise / Sunset" from the utility page, using the steps described on page 131.
2. The flashing cursor highlights the waypoint field. Use the small (CLR) and large (ENT) right knobs to enter the identifier of the waypoint at which you wish to determine sunrise and sunset times. Press ENT when finished. (To determine sunrise/sunset times for your present position, press CLR, followed by ENT.)
3. The flashing cursor moves to the date field. Use the small (CLR) and large (ENT) right knobs to enter the date for which you wish to determine sunrise and sunset times.
4. Press ENT to calculate sunrise and sunset times for the selected location and date.

Utility Page: Software / Database Ver.

The *software / database version page* displays software version information for each of the various subsystems contained within the GNC 420, as well as database versions for the Jeppesen NavData® card and built-in land data. This page is for information purposes only—no user functions are available from this page.



Setup 1 Page



The *setup 1* page provides access (via “menu options”) to airspace alarms, CDI scale adjustment, an arrival alarm, units of measure settings, position formats, map datums and settings for local or UTC time display. When a menu option is selected, the corresponding page will appear providing access to the various unit settings.

To select a menu option from the setup 1 page:

1. Press the small right knob (**PUSH CRSP**) momentarily, to activate the flashing cursor.
2. Rotate the large right knob (**CRS**) to select the desired menu option, and press **ENT**.

The following menu options are available:

Airspace Alarms— allows you to turn the controlled / special-use airspace message alerts on or off. This will not affect the alerts listed on the nearest SUA page or the airspace boundaries depicted on the map page. It will simply turn on/off the warning provided when you are approaching or near an airspace.

An altitude buffer is also provided which “expands” the vertical range above or below an airspace. For example, if the buffer is set at 500 feet, and you are more than 500 feet above or below an airspace, you will not be notified with an alert message; if you are less than 500 feet above or below an airspace and projected to enter it, you will be notified with an alert message. The default is 200 feet.

AUX PAGES

8

Set-Up 1

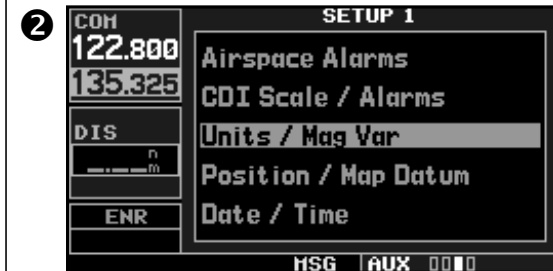

8

AUX PAGES

Setup 1

CDI scales and corresponding modes:



Enroute



Terminal



Approach

CDI Scale / Alarms— allows you to define the scale for the GNC 420’s on-screen course deviation indicator. The scale values represent full scale deflection for the CDI to either side. The default setting is “Auto”, which starts the CDI scale at 5 nm (en route), and gradually ramps the scale down through 1 nm (terminal area) to 0.3 nm during an approach. For auto CDI scaling adjustments to occur, you must have an active direct-to or flight plan with an airport or approach as your final destination, or be within 30 nm of a departure airport. Note that the Receiver Autonomous Integrity Monitoring (RAIM) protection limits listed below follow the selected CDI scale, changing automatically with the “Auto” setting:

CDI Scale	RAIM Protection
+/-5.0 nm or Auto (en route)	2.0 nm
+/-1.0 nm or Auto (terminal)	1.0 nm
+/-0.3 nm or Auto (approach)	0.3 nm

An arrival alarm, provided on the *CDI scale / alarms* page, may be set to notify you with a message when you have reached a user-defined distance to the final destination (the direct-to waypoint or the last waypoint in a flight plan). Once you have reached the set distance (up to 99.9 units), an “Arrival at [waypoint]” message will be displayed.

Units / Mag Var— allows you to configure the displayed data to standard or metric units of measure. This setting applies to distance, speed, altitude, fuel, pressure and temperature. Also provides three magnetic variation (heading) options: True, Auto or User-defined. If “Auto” is selected, all track, course and heading information will be corrected to the magnetic variation computed by the GPS receiver. The “True” setting will reference all information to true north, and the “User” setting will correct information to an user-entered value.

Position / Map Datum— configures position readout information to the desired position format and datum. The NavData® card contains over 100 map datums to adjust your position reading, making it conform to specific paper charts. If you are using a chart based on another datum, you must set the GNC 420 to use the same datum. Using a map datum that does not match the charts you are using can result in significant differences in position information. If you are using the paper charts for reference only, the GNC 420 will still provide correct navigation guidance to the waypoints contained in the database, regardless of the datum selected.

Date / Time— provides settings for time format (local or UTC; 12- or 24-hour) and time offset. The time offset is used to define current local time. UTC (also called “GMT” or “zulu”) date and time are calculated directly from the GPS satellites’ signals and cannot be changed. If you prefer to use local time, simply designate the offset by adding or subtracting the correct number of hours.

Setup 1 Page: Airspace Alarms

To set the airspace warning messages or change the altitude buffer:

1. Select “Airspace Alarms” from the setup 1 page, using the steps described on page 138.
2. Rotate the large right knob (⊖) to highlight the “On/”Off field next to the desired airspace type. (“Other SUAs” includes alert, caution, danger, training and warning areas.)
3. Rotate the small right knob (⊕) to select “On” or “Off”, as desired. Press **ENT** to accept the selection.
4. To change the altitude buffer, rotate the large right knob (⊖) to highlight the “Altitude Buffers” field. Use the small (⊕) and large (⊖) right knobs to enter the desired buffer distance. Press **ENT** when finished.

NOTE

When an approach has been loaded into the active flight plan, airspace alert messages will be disabled within 30 nm of the destination airport.

AUX PAGES

Setup 1

8



1



3



4

8

AUX PAGES

Setup 1

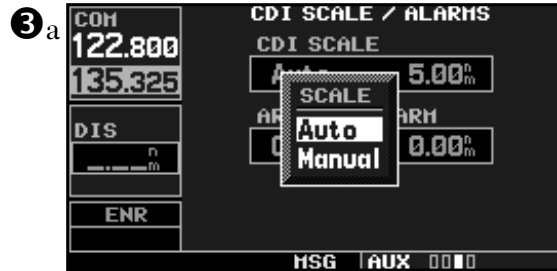

Setup 1 Page: CDI Scale / Alarms

To change the CDI scale:

1. Select "CDI Scale / Alarms" from the setup 1 page, using the steps described on page 136.
2. Rotate the large right knob (⊖) to highlight the "Auto"/"Manual" field. (The scales and applicable flight phases for the "Auto" selection are described on page 141.)
- 3a. Rotate the small right knob (PUSH CRB) to select "Auto" or "Manual", as desired. Press ENT to accept the selection.
4. If "Manual" CDI scaling is selected, the flashing cursor moves to the scale field (to the immediate right of "Manual"). Rotate the small right knob (PUSH CRB) to select the desired CDI scale. Press ENT when finished.

To set the arrival alarm and alarm distance:

1. Select "CDI Scale / Alarms" from the setup 1 page, using the steps described on page 138.
2. Rotate the large right knob (⊖) to highlight the "On"/"Off" field (directly below "Arrival Alarm").
- 3b. Rotate the small right knob (PUSH CRB) to select "On" or "Off", as desired. Press ENT to accept the selection.
4. The flashing cursor moves to the alarm distance field (to the immediate right of "On" or "Off"). To enter an arrival alarm distance, use the small (PUSH CRB) and large (⊖) right knobs to enter the desired alarm distance. Press ENT when finished.

NOTE

The CDI scale is always measured in nautical miles, regardless of the current distance units of measure selected on the units/mag var page.

Setup 1 Page: Units / Mag Var

To set the magnetic variation:

1. Select "Units / Mag Var" from the setup 1 page, using the steps described on page 138.
- 2a. The flashing cursor highlights the heading mode field. Rotate the small right knob (PUSH) to select the desired heading mode: Auto, True or User. Press ENT to accept the selection. (The heading modes are described on page 141.)
3. If "User" is selected, the flashing cursor moves to the user value field (to the immediate right of "User"). Use the small (PUSH) and large (PUSH) right knobs to enter the desired magnetic variation direction and value. Press ENT when finished.

To change the units of measure:

1. Select "Units / Mag Var" from the setup 1 page, using the steps described on page 138.
- 2b. Rotate the large right knob (PUSH) to highlight the desired units of measure category. The following categories, and corresponding units of measure, are available:
 - **DIS, SPD**—distance and speed in Nautical (nautical miles/knots), Statute (miles/miles per hour) or Metric (kilometers/kilometers per hour) terms.
 - **ALT, VS**—altitude and vertical speed in Feet/feet per minute, Meters/meters per minute, or Meters/meters per second.
 - **PRESSURE**—barometric pressure in Inches or Millibars.
 - **TEMP**—temperature in degrees Celsius or Fahrenheit.
 - **FUEL**—fuel units in Gallons, Imperial Gallons, Kilograms, Liters or Pounds.
3. Rotate the small right knob (PUSH) to select the desired units of measure for the selected category. Press ENT to accept the selection.

AUX PAGES

Setup 1

8

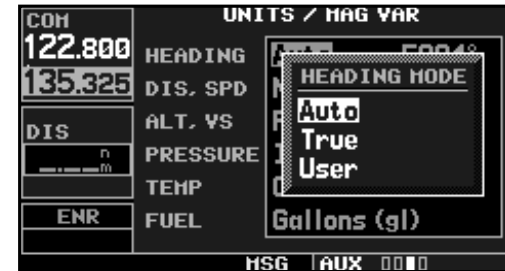

8

AUX PAGES

Setup 1

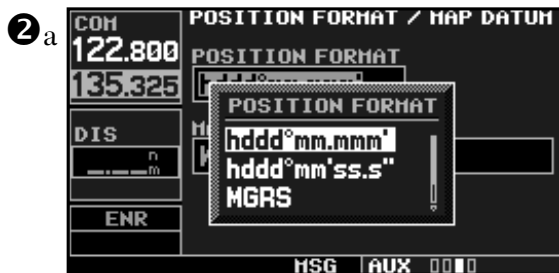

Setup 1 Page: Position Format / Map Datum

To change the position format:

1. Select "Position Format / Map Datum" from the setup 1 page, using the steps described on page 138.
- 2a. The flashing cursor is on the position format field. Rotate the small right knob (PUSH CRSEL) to select the desired position format. The following position formats are available:
 - hddd°mm.mmm'—latitude and longitude in degrees and decimal minutes
 - hddd°mm'ss.s"—latitude and longitude in degrees, minutes and decimal seconds
 - MGRS—Military Grid Reference System
 - UTM/UPS—Universal Transverse Mercator / Universal Polar Stereographic grids
3. Press ENT to accept the selected format.

To change the map datum:

1. Select "Position Format / Map Datum" from the setup 1 page, using the steps described on page 138.
- 2b. Rotate the large right knob (PUSH CRSEL) to highlight the map datum field.
3. Rotate the small right knob (PUSH CRSEL) to display a window showing the available map datums.
4. Continue rotating the small right knob (PUSH CRSEL) to select the desired map datum. (See page 170 for a list of available map datums.)
5. Press ENT to accept the selected datum.

NOTE

Per TSO C129a, the WGS-84 map datum should be used in the United States. For use outside the U.S., select the geodetic datum required by that country.

Setup 1 Page: Date / Time

To display local time or UTC:

1. Select "Date / Time" from the setup 1 page, using the steps described on page 138.
- 2a. The flashing cursor highlights the time format field. Rotate the small right knob (PUSH) to display a window of available time formats: Local 12hr, Local 24hr, or UTC.
3. Continue rotating the small right knob (PUSH) to select the desired time format.
4. Press **ENT** to accept the selection.

To set the local time:

1. Select "Date / Time" from the setup 1 page, using the steps described on page 138.
- 2b. Rotate the large right knob to highlight the time offset field.
3. Use the small (PUSH) and large (PUSH) right knobs to enter the desired offset, beginning by entering a minus (-) or plus (+) sign to indicate whether the offset is behind UTC or ahead of UTC. (In the United States, all local time offsets will use be minus, or behind UTC.)
4. Press **ENT** to accept the selected offset.

Restoring Factory Settings

When making changes to any *setup 1 page* option, a "Restore Defaults?" menu selection allows you to restore the original factory settings (for the selected option only). For example, with the *airspace alarms page* displayed, the "Restore Defaults?" option will restore all *airspace alarms page* settings to the original factory values.

To restore a setup 1 option to the original factory settings:

1. Select the desired menu option from the setup 1 page, using the steps described on page 138.
- 2c. Press **MENU** to display a page options window.
3. With "Restore Defaults?" highlighted, press **ENT**.

AUX PAGES

Setup 1

8



8

AUX PAGES

Setup 2



Setup 2 Page

Menu Options: to select, highlight with cursor and press **ENT**.

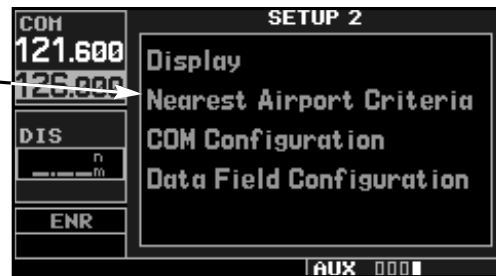

Fourth Page in AUX group

The *setup 2 page* provides access (via “menu options”) to display adjustments, parameters which define the nearest airport search, and COM transceiver channel spacing. When a menu option is selected, the corresponding page will appear providing access to the various unit settings.

To select a menu option from the *setup 2 page*:

1. Press the small right knob (PUSH CURSOR) momentarily, to activate the flashing cursor.
2. Rotate the large right knob (ENT) to select the desired menu option, and press **ENT**.

The following menu options are available:

Display— allows you to adjust the display for optimum viewing in any condition. Automatic backlighting is available which uses a built-in photocell (at the top left corner of the display bezel) to make the proper display adjustments without any user intervention. Automatic contrast adjustment varies the screen contrast level based upon current unit temperature. You may also select manual control of the display contrast and backlighting to tailor the GNC 420’s display to your needs.

NOTE

Display backlighting changes are not saved when the GNC 420 is turned off. Backlighting will revert to the “Auto” setting the next time the unit is turned on.

Nearest Airport Criteria— defines the minimum runway length and surface type used when determining the nine nearest airports to display on the *nearest airport page*. A minimum runway length and/or surface type may be entered to prevent airports with small runways, or runways that are not of appropriate surface, from being displayed. The default settings are “0 feet (or meters)” for runway length and “any” for runway surface type.

COM Configuration— allows you to select 8.33 kHz or 25.0 kHz COM frequency channel spacing.

NOTE

8.33 kHz VHF communication frequency channel spacing is not approved for use in the United States. Select the 25.0 kHz channel spacing option.

Setup 2 Page: Display

To change the backlighting intensity:

1. Select “Display” from the setup 2 page, using the steps described on page 145.
- 2a. The flashing cursor highlights the backlight mode field. Rotate the small right knob (PUSH CRSEL) to select the desired mode: Auto or Manual. Press ENT to accept the selection.
3. If “Manual” is selected, the flashing cursor moves to the backlight level field. Rotate the small right knob (PUSH CRSEL) to select the desired level. Press ENT to accept the selection.

To change the display contrast:

1. Select “Display” from the setup 2 page, using the steps described on page 145.
- 2b. Rotate the large right knob to highlight the contrast mode field.
3. Rotate the small right knob (PUSH CRSEL) to select the desired mode: Auto or Manual. Press ENT to accept the selection.
4. If “Manual” is selected, the flashing cursor moves to the contrast level field. Rotate the small right knob (PUSH CRSEL) to select the desired level. Press ENT to accept the selection.

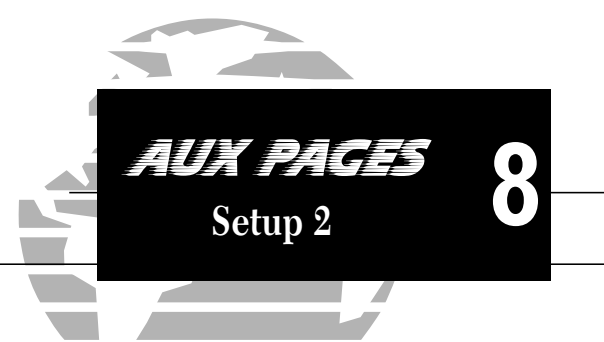

8

AUX PAGES

Setup 2

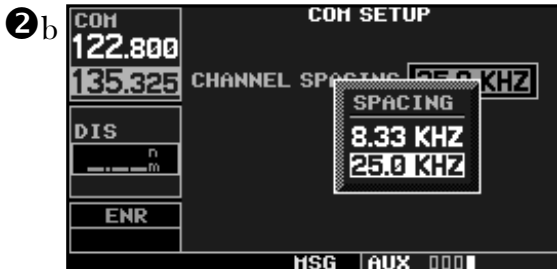

Setup 2 Page: Nearest Airport Criteria

To set the minimum runway length and runway surface:

1. Select "Nearest Airport Criteria" from the setup 2 page, using the steps described on page 147.
- 2a. The flashing cursor highlights the runway surface field. Rotate the small right knob (PUSH CRSP) to select the desired surface. The following options are available:
 - Any surface
 - Hard surfaces Only
 - Hard / Soft surfaces
 - Water landings only
3. Press **ENT** to accept the runway surface selection.
4. The flashing cursor moves to the minimum runway length field. To enter a different minimum runway length, use the small (PUSH CRSP) and large (PUSH CRSP) right knobs to enter the desired length. Press **ENT** when finished.

Setup 2 Page: COM Configuration

To set the COM channel spacing:

1. Select "COM Configuration" from the setup 2 page, using the steps described on page 145.
- 2b. The flashing cursor highlights the channel spacing field. Rotate the small right knob (PUSH CRSP) to select the desired channel spacing: 8.33 kHz or 25.0 kHz. Press **ENT** when finished.

Restoring Factory Settings

When making changes to any *setup 2 page* option, a “Restore Defaults?” menu selection allows you to restore the original factory settings (for the selected option).

To restore a **setup 2** option to the original factory settings:

1. Select the desired menu option from the setup 2 page, using the steps described on page 145.
- 2c. Press **MENU** to display a page options window.
3. With “Restore Defaults?” highlighted, press **ENT**.



9

MESSAGES, ABBREVIATIONS & NAV TERMS

Section 9

Messages, Abbreviations and Navigation Terminology

Messages

The GNC 420 uses a flashing “MSG” annunciator at the bottom of the screen (directly above the **MSG** key) to alert you of any important information or warnings. While most messages are advisory in nature, warning messages may require your intervention.

Whenever the “MSG” annunciator flashes, press the **MSG** key to display the message. Press **MSG** again to return to the previous page.

The following is a list of available messages and their meanings:

Airspace ahead -- less than 10 minutes—Your GPS-calculated course is projected to enter a special use airspace within 10 minutes. This message is automatically disabled within 30 nautical miles of an arrival airport, when an approach is loaded.

Airspace near and ahead—Your GPS-calculated position is within 2 nautical miles of the boundary of a special use airspace and your course is projected to enter the airspace within 10 minutes. This

message is automatically disabled within 30 nautical miles of an arrival airport, when an approach is loaded.

Altitude input failure—The GNC 420 is configured to receive altitude serializer data (Icarus, Rosetta or Shadin) and it is not being received. Or, the data was being received, but has been interrupted. If a grey code altitude input is available, it will be used instead. If the problem persists, contact your GARMIN dealer and check the installation and installation settings. When this message occurs, no pilot action is required if enough satellites are available for a 3D position fix (provided no RAIM warnings are present). However, if only a 2D position fix is possible, the pilot should maintain the GPS altitude within 1,000 feet of pressure altitude—by entering the altitude on the *position page*.

Approach is not active—The approach could not transition to “active”, at 2 nautical miles or closer to the FAF. Verify that “SUSP” DOES NOT appear directly above the **NRST** key, indicating the auto waypoint sequencing is suspended. This message also appears if Receiver Autonomous Integrity Monitoring (RAIM) has determined that sufficient GPS satellite coverage DOES NOT exist for the phase of flight you are currently in (along with a “RAIM not available from FAF to MAP” message). Lastly, if you select a “manual” CDI scale within the terminal area of the arrival airport, the approach cannot be activated. (The GNC 420 will automatically reset a “manual” CDI scale setting to “auto” at 30 nautical miles from the arrival airport.)



Approaching target altitude—The current GPS-computed altitude is within 500 feet of the final Vertical Navigation target altitude.

Approaching VNAV profile—You are within one minute of reaching the initial Vertical Navigation descent, or climb, point.

Arrival at waypoint [waypoint name]—You are within the arrival alarm circle for the indicated waypoint. The size of the arrival alarm circle is defined from the “CDI / alarms” menu option on the *setup 1* page.

Auto CDI scale selected—The CDI scale has been set to “Auto” scale adjustment to accommodate the various flight phases: en route, terminal and approach. When a “Manual” CDI scale is selected from the *setup 1* page, the GNC 420 will revert back to “Auto” within 30 nautical miles of a destination airport. The GNC 420 will also revert back to the “Auto” setting upon next power up—the “Manual” setting is NOT saved when the GNC 420 is turned off.

Cannot navigate locked FPL—You have attempted to navigate a flight plan (FPL) with one or more locked waypoints. A waypoint can be “locked” when the NavData® card is replaced and the waypoint(s) does not exist in the new database.

Can't change an active waypoint—An attempt has been made to modify the position of the active “to” or “from” waypoint. The GNC 420 will not allow modifications to user waypoints currently being utilized for navigation guidance.

Can't delete an active or FPL waypoint—An attempt has been made to delete the active “to” or “from” waypoint. The GNC 420 will not allow you to delete user waypoints currently being utilized for navigation guidance.

Check unit cooling—The GNC 420 has detected excessive display backlighting temperature. The backlighting has been automatically dimmed to reduce the temperature. Check for adequate ventilation or check cooling air flow. Contact your GARMIN dealer for assistance.

COM has failed—The GNC 420 has detected a failure in its communications transceiver. The COM transceiver is not available and the unit should be returned to your GARMIN dealer for service.

COM is not responding—Internal system-to-system communication between the main processor and the COM transceiver has failed. Operational status of the COM transceiver is unknown and the unit should be returned to your GARMIN dealer for service.



COM needs service—The GNC 420 has detected a failure in its communications transceiver. The COM transceiver may still be usable, but the unit should be returned (at your earliest convenience) to your GARMIN dealer for service.

COM push-to-talk key stuck—The external push-to-talk (PTT) switch is stuck in the enabled (or “pressed”) state. Try pressing the PTT switch again to cycle its operation. If the message persists, contact your GARMIN dealer for assistance.

9

MESSAGES, ABBREVIATIONS & NAV TERMS

COM remote transfer key is stuck—The remote COM transfer switch is stuck in the enabled (or “pressed”) state. Try pressing the switch again to cycle its operation. If the message persists, contact your GARMIN dealer for assistance.

COM transfer key stuck—The  key is stuck in the enabled (or “pressed”) state. Try pressing the  key again to cycle its operation. If the message persists, contact your GARMIN dealer for assistance.

COM transmitter power has been reduced—The GNC 420 has detected excessive unit temperature and/or an insufficient voltage level. The COM transceiver transmit power has been automatically reduced to compensate for the condition. For excessive temperatures, check for adequate ventilation or check cooling air flow. If the message persists, contact your GARMIN dealer for assistance.

Data card failure—The GNC 420 has detected a problem with the NavData® card. The data is not usable and the card should be returned to Jeppesen or your GARMIN dealer.

Data transfer cancelled (cross-fill busy)—An attempt to transfer flight plan data during a unit-to-unit crossfill was cancelled. The

host unit is busy or unable to communicate. Wait until any previous crossfill operation is complete, before re-attempting the transfer.

Data transfer cancelled (data invalid)—An attempt to transfer a single user waypoint during a unit-to-unit crossfill was cancelled. No waypoint was specified on the *crossfill page*. Select a user waypoint and re-attempt the transfer.

Data transfer cancelled (version mismatch)—An attempt to transfer data during a unit-to-unit crossfill was cancelled. The operating software and/or database versions of the two 400 series units are not identical. If necessary, update the database(s) so they match. Operating software changes may require factory service. Contact your GARMIN dealer for assistance.

Data transfer error, please re-transmit—An error was detected during unit-to-unit crossfill of user data (user waypoints and/or flight plans). The data transfer should be re-attempted.

Data transfer is complete—The unit-to-unit crossfill of user data (user waypoints and/or flight plans) has finished.

Database changed, validate user modified procedures—You have modified one or more approaches, departures or arrivals from their original published form. When the NavData® card is replaced (database update), you must manually verify your changes in the new database. This message will occur each time a flight plan containing a modified procedure (generated from a prior database version) is activated. To eliminate the message, re-create the flight plan from the new database, then make the desired modifications.

Degraded accuracy—GPS position accuracy has been degraded and RAIM is not available. Poor satellite geometry (or coverage) has

resulted in a horizontal DOP greater than 4.0. Additional cross-checking using another navigation source is required to verify the integrity of the GPS position.

Display backlight failure—The GNC 420 has detected a failure in the display backlighting. The unit should be taken to your GARMIN dealer for service.

Do not use for navigation—The GNC 420 is in Demo Mode and must not be used for actual navigation.

FPL has been truncated—The flight plan (FPL) was truncated because not enough room existed to insert an approach, departure or arrival. This may occur upon power up when a database change increases the number of waypoints within an instrument procedure.

FPL is full - remove unnecessary waypoints—An attempt has been made to add more than 31 waypoints to a flight plan (FPL). The GNC 420 will not allow more than 31 waypoints per flight plan.

FPL leg will not be smoothed—The upcoming flight plan (FPL) leg is too short for smooth waypoint transitions. Expect a rapid change in the CDI.

FPL waypoint is locked—At least one flight plan (FPL) waypoint is locked because the waypoint has been removed from the current NavData® card (database change), the data card is missing, or the data card has failed.

FPL waypoint moved—The position data for one or more flight plan (FPL) waypoints moved at least 0.33 arc minutes in the current NavData® card (database change).



FPL waypoint was deleted—At least one flight plan (FPL) waypoint is no longer available when a new NavData® card was installed (database change).

GPS has failed—The GNC 420 has detected a failure in its GPS receiver. The GPS receiver is not available and the unit should be returned to your GARMIN dealer for service.

GPS is not responding—Internal system-to-system communication between the main processor and the GPS receiver has failed. Operational status of the GPS receiver is unknown and the unit should be returned to your GARMIN dealer for service.

GPS needs service—The GNC 420 has detected a failure in its GPS receiver. The GPS receiver may still be usable, but the unit should be returned (at your earliest convenience) to your GARMIN dealer for service.

GPS stored data was lost—Satellite almanac, ephemeris and time data have been lost due to a memory battery failure, system reset or data expiration (data over six months old).

9

MESSAGES, ABBREVIATIONS & NAV TERMS

Inside airspace—Your GPS-calculated position lies within the boundaries of a special use airspace. This message is automatically disabled within 30 nautical miles of an arrival airport, when an approach is loaded.

Invalid closest pt of FPL—A closest point cannot be created from the waypoint entered on the “Closest point of flight plan” window. This occurs when the selected waypoint is beyond the limits of all legs in the flight plan, too far away, or when a unique waypoint name for the closest point cannot be created.

Invalid FPL modifications—An attempt was made to modify the final course segment (FAF to MAP) of an instrument approach. The GNC 420 will not allow the modifications.

Invalid waypoint ident—An attempt was made to create a user waypoint with an invalid name. The GNC 420 will not allow spaces between characters in the waypoint name.

MAIN processor requires service—The GNC 420 has detected a failure in the main system processor. The GNC 420 is not usable and should be taken to your GARMIN dealer for service.

Memory battery low—The internal battery that sustains user memory is low and should be replaced by a GARMIN dealer as soon as possible. Failure to do so may result in loss of stored data, including flight plans, user waypoints, unit settings and satellite data.

Near airspace -- less than 2 nm—Your GPS-calculated position is within 2 nautical miles of a special use airspace boundary, but you are not projected to enter the airspace. This message is automatically disabled within 30 nautical miles of an arrival airport, when an approach is loaded.

Need altitude - display position page—The GPS receiver needs altitude input in order to start and/or continue 2D navigation. Select the position page and verify the altitude reading. If the altitude is in error by more than 500 feet, enter the current altitude as accurately as possible. An inaccurate altitude will directly translate into inaccurate position information.

No altitude input is being received—No altitude data is being received from RS-232 (Serializer: Icarus, Rosetta or Shadin) or grey code inputs. If the problem persists, contact your GARMIN dealer and check the installation and installation settings. When this message occurs, no pilot action is required if enough satellites are available for a 3D position fix (provided no RAIM warnings are present). However, if only a 2D position fix is possible, the pilot should maintain the GPS altitude within 1,000 feet of pressure altitude—by entering the altitude on the *position page*.

No basemap data available—The GNC 420 has detected a failure in the built-in basemap (land data) memory. Land data will not appear on the *map page*. Other unit functions will continue to work



normally, however the GNC 420 should be taken to your GARMIN dealer for service at your earliest convenience.

Non-WGS84 wpt navigation—The active “to” and/or “from” waypoints are based upon a map datum other than WGS 84 and cannot be converted from that map datum to WGS 84. Expect some error in the position of the waypoint(s) and cross-check with an alternate means of navigation.

Not receiving input data on 429 Channel #1—No data has been received on the ARINC 429 channel #1 connection for a period exceeding five seconds. If the problem persists, the installation should be checked by your GARMIN dealer.

Not receiving input data on 429 Channel #2—No data has been received on the ARINC 429 channel #2 connection for a period exceeding five seconds. If the problem persists, the installation should be checked by your GARMIN dealer.

Not receiving input data on 232 Channel #1—No data has been received on the RS-232 channel #1 connection for a period exceeding ten seconds. If the problem persists, the installation should be checked by your GARMIN dealer.

OBS key stuck—The  key is stuck in the enabled (or pressed) state. Try pressing the  key again to cycle its operation. If the message persists, contact your GARMIN dealer for assistance.

Poor GPS coverage—The GPS receiver cannot acquire a sufficient number of satellites to compute a position and provide navigation.

Power down and re-initialize—The GNC 420 cannot calculate a position due to abnormal satellite conditions. The unit is unusable



until power has been cycled off and back on. Abnormal satellite conditions may exist and you may need to use an alternate means of navigation.

RAIM is not available—Receiver Autonomous Integrity Monitoring (RAIM) has determined that sufficient GPS satellite coverage DOES NOT exist for the phase of flight you are currently in. (The CDI/HSI NAV flag will also appear.) Select an alternate source for navigation guidance, such as an external VLOC receiver.

RAIM not available from FAF to MAP waypoints—When performing an instrument approach, Receiver Autonomous Integrity Monitoring (RAIM) has determined that sufficient GPS satellite coverage DOES NOT exist to meet the required protection limits. Select an alternate source for navigation guidance, such as the an external VLOC receiver (for a VOR or localizer-based approach).

RAIM position warning—Although sufficient GPS satellite coverage may exist, Receiver Autonomous Integrity Monitoring (RAIM) has determined the information from one or more GPS satellites may be in error. The resulting GPS position may be in error beyond the

9

MESSAGES, ABBREVIATIONS & NAV TERMS

limits allowed for your current phase of flight. Cross-check your position with an alternate navigation source. If the warning occurs during a final approach segment (FAF to MAP), execute the published missed approach.

Scheduler message -- [user entered text]—The user-entered scheduler message time has expired, and the scheduler message is displayed.

Searching the sky—The GNC 420 is searching the sky for GPS satellite almanac data or the GPS receiver is in AutoLocate Mode. Allow the unit to complete data collection (approximately 5 minutes) before turning it off.

Select auto sequence mode—The **OBS** key was pressed, disabling auto sequencing of waypoints (in a flight plan or instrument procedure). The **OBS** key should be pressed again to enable auto sequencing, because 1) no destination waypoint has been selected, or 2) the GPS receiver cannot currently determine its position.

Set course to [###]°—The course select for the external CDI (or HSI) should be set to the specified course. The message will only

occur when the current selected course is greater than 10° different from the desired track.

Steep turn ahead—This message appears approximately one minute prior to a turn in one of the following three conditions: 1) the turn requires a bank angle in excess of 25° in order to stay on course, 2) the turn requires a course change greater than 175°, or 3) during a DME arc approach the turn anticipation distance exceeds 90 seconds.

Stored data was lost—All user waypoints, flight plans and system settings have been lost due to a memory battery failure or system reset.

Timer has expired—The count down timer has reached zero.

Unit configuration has changed—The GNC 420 has detected a failure (during initial power up) in its system configuration. Some system components may be unusable. Try cycling power off and back on. If the message persists, contact your GARMIN dealer for assistance.

User card format unknown—A data card has been inserted, but the format of the card is not recognized.

Waypoint already exists—The name you have entered for a user waypoint already exists in memory.

Waypoint(s) have been replaced—One or more user waypoints were updated during a unit-to-unit crossfill operation.

Waypoint memory is full—You have used all 1000 user waypoint locations in the GNC 420's memory. Delete unwanted waypoint to make room for new entries.

WGS 84 datum has been selected—The system map datum was changed to WGS 84 because the selected map datum was removed from the current NavData® card (database update), the data card is missing or the data card has failed.



9

MESSAGES, ABBREVIATIONS & NAV TERMS

Abbreviations

The following is a list of abbreviations used on the GNC 420 and their meanings:

ACTV —	Active	BARO —	Barometric Pressure	DTK —	Desired Track
ALT —	Altitude	BRG —	Bearing To	EFF —	Efficiency
APPRCHING —	Approaching	°C —	Degree Celsius	ELEV —	Elevation
APR —	Approach	CAS —	Calibrated Airspeed	ENDUR —	Endurance
APT —	Airport	CDI —	Course Deviation Indicator	ENR —	En Route
ARSPC —	Airspace	CLR —	Clear	ENT —	Enter
ARTCC —	Air Route Traffic Control Center	COM —	Communications Transceiver	EPE —	Estimated Position Error
ARVL —	Arrival	CRSR —	Cursor	ESA —	En Route Safe Altitude
AUX —	Auxiliary	CTA —	ICAO Control Area	ETA —	Estimated Time of Arrival
AVGAS —	Aviation-grade Gasoline	CTAF —	Common Traffic Advisory Frequency	ETE —	Estimated Time En Route
AVTN —	Aviation	CTR —	Center (see ARTCC)	°F —	Degrees Fahrenheit
		CTS —	Course To Steer	FF —	Fuel Flow
		CUM —	Cumulative	FOB —	Fuel On Board
		DB —	Database	FPL —	Flight Plan
		DEN —	Density	fpm —	Feet Per Minute
		DEP —	Departure	FREQ —	Frequency
		DIS —	Distance	FSS —	Flight Service Station
		DME —	Distance Measuring Equipment	ft —	Feet
		DOP —	Dilution of Precision	gl —	gallons



GPS— Global Positioning System
GS— Ground Speed

HDG— Heading
hg— Inches of Mercury
HWY— Highway

ID— Identifier
ig— Imperial Gallons
ILS— Instrument Landing System
IND— Indicated
INT— Intersection
INTEG— Integrity

kg— Kilograms
kHz— Kilohertz
km— Kilometers
kph— Kilometers Per Hour
kt— Knots

LAT/LON—Latitude/Longitude
lb— Pounds

LCL— Local
LFOB— Left-over Fuel On Board
LRES— Left-over Fuel Reserve Time
Lrg— Large
lt— Liters

°M— Degrees Magnetic
m— Meters
mb— Millibars of Pressure
Med— Medium
MHz— Megahertz
mi— Statute Miles
MOA— Military Operations Area
mph— Statute Miles Per Hour
mpm— Meters Per Minute
mps— Meters Per Second
MSA— Minimum Safe Altitude
MSG— Message
MSL— Mean Sea Level
mul— Multicom

NATNL— National

NAV— Navigation
NAVAID— Navigational Aid
NDB— Non-Directional Radio Beacon
nm— Nautical Miles
NRST— Nearest
NUM— Number

OBS— Omnibearing Selector

PPOS— Present Position
PROC— Procedure(s)
PROV— Province
PWR— Power

RAD— Radial

9

MESSAGES, ABBREVIATIONS & NAV TERMS

RAD— Radial
RAIM— Receiver Autonomous Integrity Monitoring
REF— Reference
REQ— Required / Requirements
RESTRICTD—Restricted
RNG— Range
RX— Receive

SID— Standard Instrument Departure
Sml— Small
SPD— Speed
SQ— Squelch
SRFC— Surface
STAR— Standard Terminal Arrival Route

SUA— Special Use Airspace
°T— Degree True
TACAN— Tactical Air Navigation
TAS— True Airspeed
TAT— Total Air Temperature
TEMP— Temperature
TERM— Terminal
TKE— Track Angle Error
TMA— ICAO Terminal Control Area
TRANS— Transition
TRK— Track (also Ground Track)
TRSA— Terminal Radar Service Area
twr— Tower
TX— Transmit

uni— Unicom
UTC— Coordinated Universal Time (also GMT or “zulu”)
VAR— Variation
VER— Version

VFR— Visual Flight Rules
VNAV— Vertical Navigation
VOL— Volume
VOR— VHF Omnidirectional Radio Range
VS— Vertical Speed
VSR— Vertical Speed Required

WPT— Waypoint
WX— Weather
XTK— Crosstrack Error

Navigation Terms

The following navigation terms are used on the GNC 420:

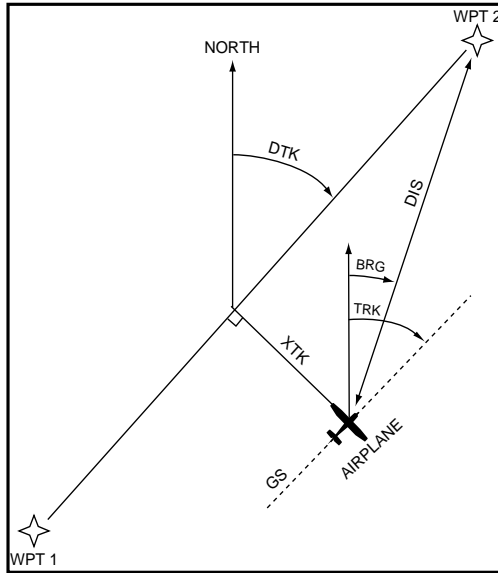

ALT(altitude)—Height above mean sea level (MSL).

BRG(bearing)—The compass direction from your present position to a destination waypoint.

CAS(calibrated airspeed)—Indicated airspeed corrected for instrument errors.

CTS(course to steer)—The recommended direction to steer in order to reduce course error or stay on course. Provides the most efficient heading to get back to the desired course and proceed along your flight plan.

CUM(cumulative)—The total of all legs in a flight plan (such as “cumulative distance”).

DIS(distance)—The “great circle” distance from your present position to a destination waypoint.

DOP(dilution of precision)—A measure of satellite geometry quality on a scale of one to ten (lowest numbers are best, highest numbers are worst).

DTK(desired track)—The desired course between the active “from” and “to” waypoints.

EFF(efficiency)—A measure of fuel consumption, expressed in distance per fuel units (e.g., nautical miles per gallon).

ENDUR(endurance)—Flight endurance, or total available flight time based upon available fuel.

EPE(estimated position error)—A measure of satellite geometry quality and additional factors, expressed as a horizontal position error in feet or meters.

ESA(en route safe altitude)—The recommended minimum altitude within a ten mile radius of your course on an active flight plan or direct-to.

ETA(estimate time of arrival)—The estimated time at which you will reach your destination waypoint, based upon current speed and track.

ETE(estimated time en route)—The time it will take to reach the destination waypoint, from present position, based upon current speed and track.

9

MESSAGES, ABBREVIATIONS & NAV TERMS

FF(fuel flow)—The fuel flow rate, expressed in fuel units per time (e.g., gallons per hour).

FOB(fuel on board)—The total amount of usable fuel on board the aircraft.

GS(ground speed)—The velocity you are travelling relative to a ground position.

HDG(heading)—The direction an aircraft is pointed, based upon indications from a magnetic compass or a properly set directional gyro.

IND(indicated)—Information provided by properly calibrated and set instrumentation in the aircraft panel (e.g., “indicated altitude”).

LFOB(left-over fuel onboard)—The amount of fuel remaining on board after the completion of a one or more legs of a flight plan (or a direct-to).

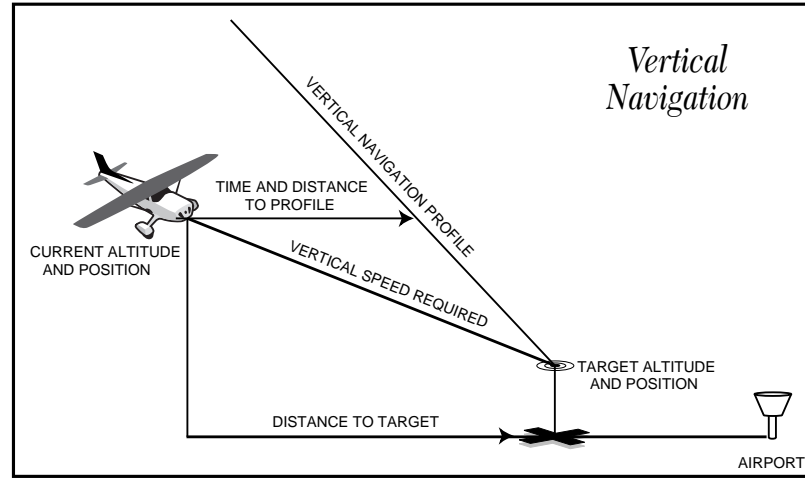

LRES(left-over fuel reserve)—The amount of fuel remaining on board after the completion of a one or more legs of a flight plan (or a direct-to), expressed in time and based upon a known fuel consumption (flow) rate.

MSA(minimum safe altitude)—Uses Grid Minimum Off-route Altitudes (Grid MORAs) to determine a safe altitude within ten miles of your present position. Grid MORAs are one degree latitude by one degree longitude in size and clear all reference points within the grid by 1000 feet in areas where the highest reference point is 5000 feet MSL or lower. If the highest reference point is above 5000 feet, the Grid MORA will clear the highest reference point by 2000 feet.

TKE(track angle error)—The angle difference between the desired track and your current track. An arrow indicates the proper direction to turn to reduce TKE to zero.

TRK(track)—The direction of movement relative to a ground position. Also referred to as “ground track”.

VSR(vertical speed required)—The vertical speed necessary to descend/climb from current position and altitude to a defined target position and altitude, based upon your current ground speed.

XTK(crosstrack error)—The distance you are off a desired course in either direction, left or right.

Appendix A: NavData Card Use

The Jeppesen NavData® card supplied with your GNC 420 can be installed or removed when the GNC 420 is on or off. Insert the card with the swing arm handle at the bottom and the label facing to the left (see illustration right). If the NavData card is not present when the unit is turned on, you will receive a “No Jeppesen Aviation Database - Limited to user defined waypoints” message on the *database confirmation page*. If the NavData card is removed during operation, a “Data card removed-Unit will restart in 30 seconds” warning. A counter will begin to count down and, if the card is not replaced within 30 seconds, the GNC 420 will automatically reinitialize. You may also reinitialize the unit manually by pressing **ENT**.

To insert the NavData card:

- 1a. Place the card into the NavData card slot, with the label facing to the left and the swing arm handle at the bottom front.

NOTE

There are two data card slots on the face of the GNC 420. The Jeppesen NavData® card should be inserted in the left-most slot. The second slot is provided for future options and expansion capabilities.

- 2a. Press the NavData card into place until it seats on the internal connector and the front of the card is flush with the face of the GNC 420 unit.
- 3a. If the swing arm handle is up, gently lower the handle and push it into place—flush with the face of the GNC 420 unit.

To remove the NavData card:

- 1b. Gently press on the tab—using a slight upward motion—at the front center of the NavData card. This will partially deploy the swing arm handle.
- 2b. Rotate the swing arm handle upward (and outward) until it locks into place, perpendicular to the face of the GNC 420 unit.
- 3b. Grasp the top and bottom surfaces of the swing arm handle, between your thumb and forefinger, and pull directly away from the face of the GNC 420 unit to unseat the connector and remove the NavData card.

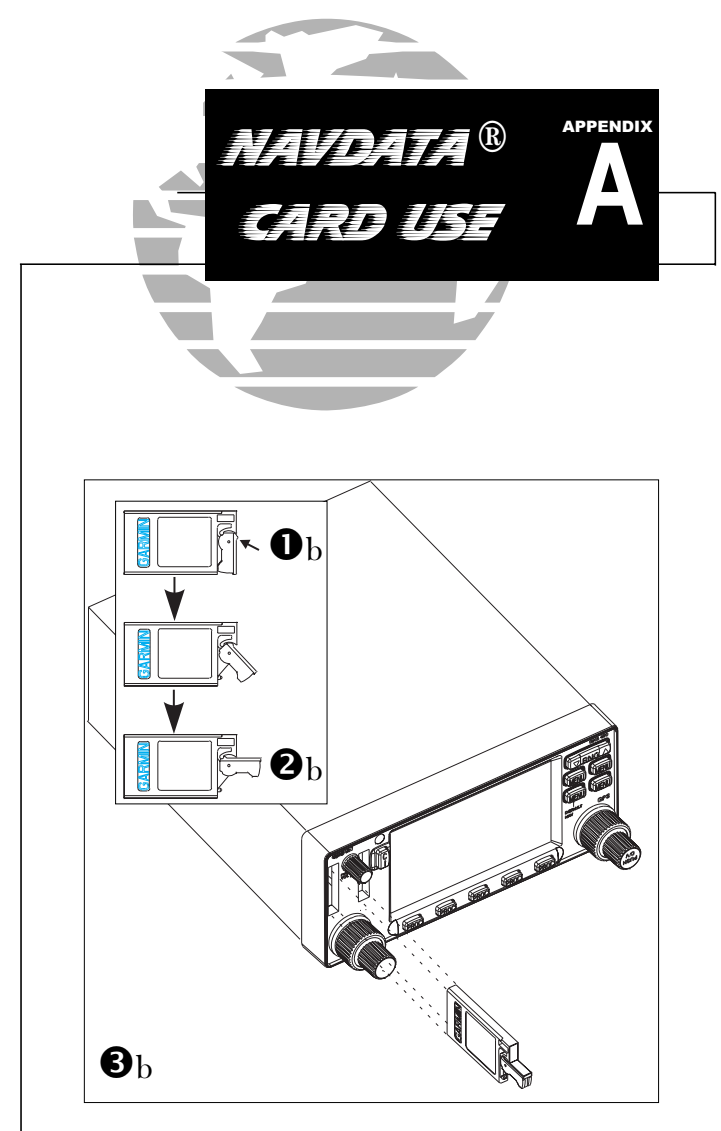



APPENDIX
B ***SPECIFICATIONS***

Appendix B: Specifications

PHYSICAL

Unit Size: 6.25" W x 11.00" D x 2.65" H
(159mm x 279mm x 67mm)
Unit Weight: 5.8 pounds installed (2.6 kg)

POWER

Input: 27.5 Volts DC (-0x version)
13.8/27.5 Volts DC (-1x version)

ENVIRONMENTAL

Temperature: -20°C to +55°C (operating range)
(-4°F to +131°F)
Humidity: 95% non-condensing
Altitude: -1,500 ft to 50,000 ft
(-457m to 15,240m)

GPS PERFORMANCE

Receiver: 12 parallel channel PhaseTrac12™
Acquisition Time: 12 seconds (warm)
45 seconds (cold)
Update Rate: Once per second, continuous
Accuracy: Position—15 meters (49 ft) RMS*
Velocity—0.1 knot RMS steady state
Dynamics: 999 kts maximum velocity
6g maximum acceleration

VHF COM PERFORMANCE

Channels: 760 (25 kHz spacing) or
2280 (8.33 kHz spacing)
Frequency Range: 118.000 MHz to 136.975 MHz
Transmit Power: 10 watts minimum

INTERFACES

ARINC 429; Aviation RS-232; CDI/HSI; RMI (digital:
clock/data); Superflag Out; Altitude (serial: Icarus, Shadin,
Rosetta or encoded: Gillham/Greycode); Fuel Sensor;
Fuel/Air Data

Appendix C: Map Datums

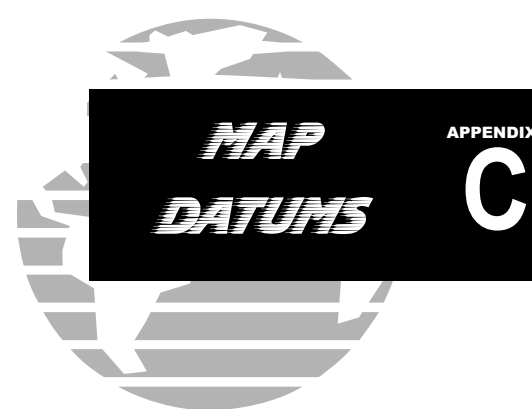

Adindan	Ethiopia, Mali, Senegal, Sudan	Chua Astro	Paraguay
Afgooye	Somalia	Corrego Alegre	Brazil
AIN EL ABD 1970	Bahrain Island, Saudi Arabia	DANISH GI 1934	Denmark
Anna 1 Astro 1965	Cocos Islands	Djakarta (BATAVIA)	Sumatra Island (Indonesia)
ARC 1950	Botswana, Lesotho, Malawi, Swaziland, Zaire, Zambia, Zimbabwe	Dos 1968	Gizo Island (New Georgia Islands)
ARC 1960	Kenya, Tanzania	Easter Island 1967	Easter Island
Ascension Is 1958	Ascension Island	European 1950	Austria, Belgium, Denmark, Finland, France, Germany, Gibraltar, Greece, Italy, Luxembourg, Netherlands, Norway, Portugal, Spain, Sweden, Switzerland
Astro B4 Sorol Atoll	Tern Island	European 1979	Austria, Finland, Netherlands, Norway, Spain, Sweden, Switzerland
Astro Beacon "E"	Iwo Jima Island	Finland Hayford 1910	Finland
Astro Dos 71/4	St. Helena Island	G. SEGARA	Borneo
Astronomic Stn 1952	Marcus Island	Gandajika Base	Republic of Maldives
Australian Geod 1966	Australia, Tasmania Island	Geodetic Datum 1949	New Zealand
Australian Geod 1984	Australia, Tasmania Island	GGRS 87	Greece
AUSTRIA NS	Austria	Guam 1963	Guam Island
BELGIUM 1950	Belgium	Gux I Astro	Guadalcanal Island
Bellevue (IGN)	Efate and Erromango Islands	Herat North	Afghanistan
Bermuda 1957	Bermuda Islands	Hjorsey 1955	Iceland
Bogota Observatory	Colombia	Hong Kong 1963	Hong Kong
BUKIT RIMPAH	Indonesia	HU-TZU-SHAN	Taiwan
CAMP AREA ASTRO	Antarctica	Indian Bngldsh NEPAL	Bangladesh, India, Nepal
Campo Inchauspe	Argentina		
Canton Astro 1966	Phoenix Islands		
Cape	South Africa		
Cape Canaveral	Florida, Bahama Islands		
Carthage	Tunisia		
CH-1903	Switzerland		
Chatham 1971	Chatham Island (New Zealand)		
			INDIAN MEAN VALUE India
			Indian Thailand Vietn Thailand, Vietnam
			INDONESIA 74 Indonesia
			Ireland 1965 Ireland
			ISTS 073 Astro 1969 Diego Garcia
			Johnston Island 1961 Johnston Island
			KANDAWALA Sri Lanka
			Kerguelen Island Kerguelen Island
			Kertau 1948 West Malaysia, Singapore
			L.C. 5 Astro Cayman Brac Island
			Liberia 1964 Liberia
			LUZON MEAN VALUE Philippines
			Luzon Mindanao Is Mindanao Island
			Luzon Philippines Philippines (excluding Mindanao Isl.)
			Mahe 1971 Mahe Island
			Marco Astro Salvage Islands
			Massawa Eritrea (Ethiopia)
			Merchich Morocco
			Midway Astro 1961 Midway Island
			Minna Nigeria
			NAD27 Alaska North American 1927- Alaska
			NAD27 Bahamas Bahamas (excluding San Salvador Island)

APPENDIX
C
MAP
DATUMS

NAD27 Canada Canada (including Newfoundland Island)

NAD27 Canal Zone Canal Zone

NAD27 Caribbean Caribbean (Barbados, Caicos Islands, Cuba, Dom. Rep., Grd. Cayman, Jamaica, Leeward and Turks Islands)

NAD27 Centrl America Central America (Belize, Costa Rica, El Salvador, Guatemala, Honduras, Nicaragua)

NAD27 CONUS Mean Value (Continental U.S.)

NAD27 Cuba Cuba

NAD27 Greenland Greenland (Hayes Peninsula)

NAD27 Mexico Mexico

NAD27 San Salvadr Is San Salvador Island

NAD83 North American 1983- Alaska, Canada,

Nahrwan Masirah Is Central America, CONUS, Mexico

Nahrwan Saudi Arabia Masirah Island (Oman)

Nahrwan Unitd Arab E Saudi Arabia

Naparima BWI United Arab Emirates

Netherland TRIAG '21 Trinidad and Tobago

NOU TRIAG France Netherlands

NOU TRIAG Luxembourg France

Observatorio 1966 Luxembourg

Old Egyptian Corvo and Flores Islands (Azores)

Old Hawaiian Kauai Egypt

Old Hawaiian Maui Kauai

Old Hawaiian MEAN Maui

Old Hawaiian Oahu Mean Value

Oman Oahu

Ord Srv Grt Britain England, Isle of Man, Scotland, Shetland Islands, Wales

Pico De Las Nieves Canary Islands

Pitcairn Astro 1967 Pitcairn Island

PORTUGUESE 1973 Portugal

POTSDAM Germany

Prov So American '56 Bolivia, Chile, Colombia, Ecuador, Guyana, Peru, Venezuela

Prov SO Chilean 1963 South Chile

Puerto Rico Puerto Rico & Virgin Isl.

Qatar National Qatar

Qornoq South Greenland

Reunion Mascarene Island

Rome 1940 Sardinia Island

RT 90 Sweden

Santo (Dos) Espirito Santo Island

Sao Braz Sao Miguel, Santa Maria Islands (Azores)

Sapper Hill 1943 East Falkland Island

Schwarzeck Namibia

South American 1969 Argentina, Bolivia, Brazil, Chile, Colombia, Ecuador, Guyana, Paraguay, Peru, Venezuela, Trinidad/Tobago

South Asia Singapore

SouthEast Base Porto Santo and Madeira Islands

SouthWest Base Faial, Graciosa, Pico, Sao Jorge and Ceira Islands (Azores)

Tananarive obsv 1925 Madagascar

Timbalai 1948 Brunei and East Malaysia (Sarawak and Sabah)

Tokyo Japan, Korea, Okinawa

Tristan Astro 1968 Tristan da Cunha

Viti Levu 1916 Viti Levu Island/Fiji Islands

Wake-Eniwetok 1960 Marshall Islands

WGS 72 World Geodetic System 1972

WGS 84 World Geodetic System 1984

YACARE Uruguay

Zanderij Surinam

Appendix D: Troubleshooting Q & A



This section is designed to answer some of the common questions regarding the GNC 420’s capabilities and operation. If you have a problem operating the unit, read through this appendix and refer to the reference section noted. If you don’t find answers to your particular question here, use the index to find the appropriate section elsewhere in this manual. If, after reading through the appropriate reference section, you still haven’t found the answer to your question, please see your authorized dealer or contact GARMIN directly at the address or phone numbers listed on page iv. GARMIN is dedicated to supporting its products and customers.

What is RAIM, and how does it affect approach operations?

RAIM is an acronym for Receiver Autonomous Integrity Monitoring, a GPS receiver function that performs a consistency check on all tracked satellites. RAIM ensures that the available satellite geometry will allow the receiver to calculate a position within a specified protection limit (2 nautical miles for oceanic and en route, 1 nm for terminal and 0.3 nm for non-precision approaches).

During oceanic, en route and terminal phases of flight, RAIM will be available nearly 100% of the time. Because of the tighter protection limit on approaches, there may be times when RAIM is not available. The GNC 420 automatically monitors RAIM and will warn you with an alert message (see Section 10) when it is not available, and the INTEG annunciator () will appear at the bottom left corner of the screen. If RAIM is not available when crossing the FAF, the pilot must fly the missed approach procedure. The GNC 420’s RAIM prediction function (see page 132) will also allow you to see whether RAIM will be available for a specified date and time.

NOTE

If RAIM is not predicted to be available for the final approach course, the approach will not become active—as indicated by an “Approach is not active” message, a “RAIM not available from FAF to MAP” message and the INTEG annunciator.



Why aren't there any approaches available for my flight plan?

Approaches are available for the final destination airport in a flight plan or as a direct-to (keep in mind that some VOR/VORTAC identifiers are similar to airport identifiers). If a destination airport does not have a GPS approach, the GNC 420 will indicate “NONE” for the available procedures—as listed on the *airport approach page*. For more information on selecting an approach, see page 66.



What happens when I select an approach? Can I store a flight plan with an approach, departure or arrival?

Whenever you load an approach, departure or arrival into the active flight plan, a set of approach, departure or arrival waypoints is inserted into the flight plan—along with a header line describing the instrument procedure you selected. The original en route portion of the flight plan will remain active, unless you “activate” the instrument procedure; which may be done when the procedure is loaded or at a later time.



Flight plans can also be stored with an approach, departure or arrival. Keep in mind that the active flight plan is erased when the unit is turned off and overwritten when another flight plan is activated. When storing flight plans with an approach, departure or arrival, the GNC 420 will use the waypoint information from the current database to define the waypoints. If the database is changed or updated, the GNC 420 will automatically update the information if the procedure has not been modified. If an approach, departure or arrival procedure is no longer available, the flight plan will become locked until the procedure is deleted from the flight plan or the correct database is installed. For information on loading an approach, departure or arrival, see page 66. See page 57 for instructions on saving and copying flight plans.

Can I file slant Golf (“/G”) using my GPS?

Yes, you may file your flight plan as /G if your GNC 420 is a certified A1 or A2 installation. If you are flying en route, you may fly /G with an expired database only after you have verified all route waypoints. Non-precision approaches may not be flown with an expired database. See your approved Airplane Flight Manual Supplement for more information.



What does the **OBS** key do and when do I use it?

The **OBS** key is used to select manual (OBS mode) or automatic waypoint sequencing of waypoints. Activating OBS mode (as indicated by an **OBS** annunciation directly above the **OBS** key) holds your current ‘active to’ waypoint as your navigation reference and prevents the GPS from sequencing to the next waypoint. When OBS mode is cancelled, automatic waypoint sequencing is selected, and the GNC 420 will automatically select the next waypoint in the flight plan once the aircraft has crossed the present active-to waypoint.

NORMAL (no “OBS” annunciator)

Automatic sequencing of waypoints
 Change in HSI does not affect CDI deflection
 Always navigates ‘TO’ the active waypoint
 Must be in this mode for final approach course

OBS

Manual sequencing- ‘holds’ on selected waypoint
 Manually select course to next waypoint from HSI
 Will indicate ‘TO’ or ‘FROM’ waypoint
 Cannot be set for final approach course or published holding patterns

Whenever OBS mode is active, the GNC 420 allows you to select the desired course to/from a waypoint using the HSI (much like a VOR) and display a to/from flag for the active-to waypoint. If an external course input is not available, you may select the OBS course on-screen, via a “Select OBS Course pop-up window. With OBS mode cancelled, the CDI will always display a ‘TO’ indication for the next waypoint once you’ve crossed the active waypoint (provided the active waypoint is not the last waypoint). Refer to page 72 for an example using the **OBS** key.

One application for the **OBS** key is holding patterns. The **OBS** key is used to suspend waypoint sequencing and select the desired course along the waypoint side of the hold. For many approach operations, setting and resetting of waypoint sequencing is automatic. Holding patterns that are part of an approach will automatically disable waypoint sequencing, then re-enable waypoint sequencing after one time around the holding pattern. A “SUSP” annunciation will appear directly above the **OBS** key (see illustration left) to indicate that automatic waypoint sequencing is temporarily suspended and course selection is not available. If more than one trip around the holding pattern is desired, press the **OBS** key to again suspend waypoint sequencing. An example of this operation is an approach which begins with a holding pattern at the initial approach fix (IAF). See page 73 for more information on the “SUSP” annunciation and approaches with holding patterns.

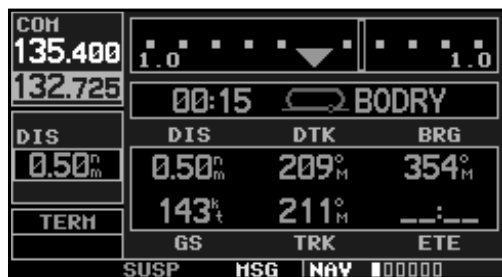

APPENDIX
D
**TROUBLE-
SHOOTING**

When should I use the **OBS key to return to auto sequencing, and what happens when I do?**

The most common application for using the **OBS** key is the missed approach. The GNC 420 will suspend automatic waypoint sequencing (indicated by a “SUSP” annunciation directly above the **OBS** key; see right) when you cross the missed approach point (MAP). This prevents the GNC 420 from automatically sequencing to the missed approach holding point (MAHP). If a missed approach is required, press the **OBS** key to return to automatic waypoint sequencing and sequence the approach to the MAHP. See page 70 for more information on missed approaches.



Why won't my unit automatically sequence to the next waypoint?

The GNC 420 will only sequence flight plan waypoints when automatic sequencing is enabled (i.e., no “OBS” or “SUSP” annunciation directly above the **OBS** key). For automatic sequencing to occur, you must also cross the “bisector” of the turn you are navigating. The bisector is a perpendicular line between two flight plan legs which crosses through the waypoint common to both legs.

How do I skip a waypoint in an approach, departure or arrival?

The GNC 420 allows you to manually select any approach, departure or arrival leg as the active leg of your flight plan. This procedure is performed from the *active flight plan page* by highlighting the desired waypoint and pressing **B->** twice, then **ENT** to approve the selection (see illustration right). The GPS will then provide navigation along the selected flight plan leg, so be sure you have clearance to that position. See page 65 for more information.



How do I fly the GPS with an autopilot and HI heading bug?

If you do not have an HSI, you should make your course selections on the external CDI's OBS knob and the HI heading bug.

When does turn anticipation begin, and what bank angle is expected?

The GNC 420 will smooth adjacent leg transitions based upon a nominal 15° bank angle (with the ability to roll up to 25°) and provide three pilot cues for turn anticipation: 1) A waypoint alert (“NEXT DTK ###°”) will flash in the lower right corner of the screen 10 seconds before the turn point. 2) A flashing turn advisory (“TURN TO ###°”) will appear in the lower right corner of the screen when you are to begin the turn. Set the HSI to the next DTK value and begin the turn. 3) The To/From indicator on the HSI (or CDI) will flip momentarily to indicate that you have crossed the midpoint of the turn. For more information on waypoint alerts and turn advisories, see section 5.

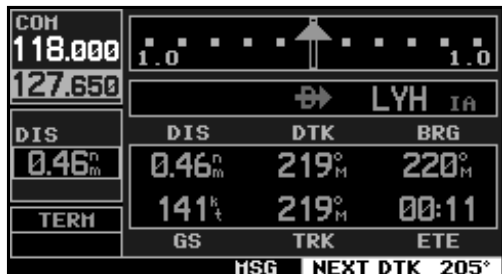

When does the CDI scale change, and what does it change to?

The GNC 420 will begin a smooth CDI scale transition from the 5.0 nm (enroute mode) to the 1.0 nm (terminal mode) scale 30 nm from the destination airport (see left). The CDI scale will further transition to 0.3 nm (approach mode) at 2 nm prior to the FAF during an active approach. If you are in a missed approach situation, and would like to return the CDI to the 1 nm scale, activate the missed approach sequence by pressing the **OBS** key, as described on page 70. The CDI scale will also be 1.0 nm (terminal mode) within 30 nm of the departure airport.

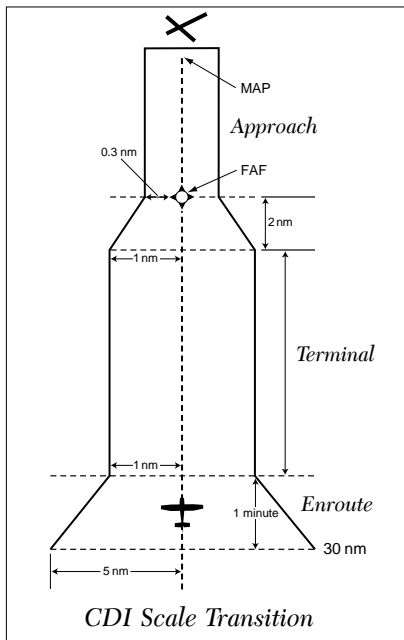

Why does my CDI not respond like a VOR when OBS mode is active?

Unlike a VOR, the CDI scale used on GPS equipment is based on the cross-track distance to the desired course, not an angular relationship to the destination (see right). Therefore, the CDI deflection on the GPS will be constant regardless of the distance to the destination, and will not become less sensitive when you are further away from the destination. For more information on the CDI scale, see page 139.

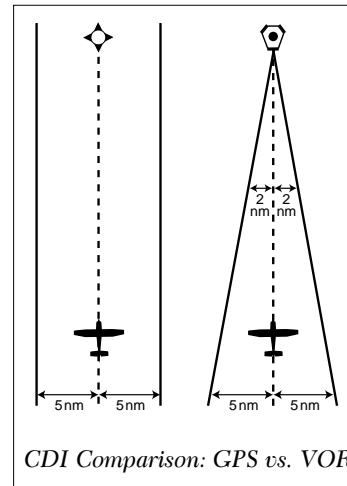

What is the correct missed approach procedure? How do I select the missed approach holding point?

To comply with TSO specifications, the GNC 420 will not automatically sequence past the MAP. The active-to waypoint will sequence to the first waypoint in the missed approach procedure, whenever the **OBS** key is pressed AFTER crossing the MAP. All published missed approach procedures must be followed, as indicated on the approach plate.

To execute the missed approach procedure prior to the MAP (not recommended), select the *active flight plan page* and use the **B>** key (by pressing it twice) to activate the missed approach portion of the procedure, as described on page 65.

How do I re-select the same approach or activate a new approach after a missed approach?

After flying all missed approach procedures, you may reactivate the same approach for another attempt from the *procedures page*. Once you have been given clearance for another attempt, activate the approach from the *procedures page* by highlighting “Activate Approach?” and then pressing **ENT**. The GNC 420 will provide navigation along the desired course to the waypoint and rejoin the approach in sequence from that point on. See page 65 for information on activating a specific flight plan leg.

To activate a new approach for the same airport, select the new procedure from the *procedures page*. To view the *procedures page*, press **PROC** and rotate the large right knob (⊕) to highlight “Select Approach?”. Press **ENT** and rotate the large right knob (⊕) to highlight the new approach you want to fly. Press **ENT** to select the approach, then select the desired transition. Finally, highlight “Activate?” at the bottom right corner of the screen and press **ENT** to activate the new approach.

To activate a new approach to a different airport, press **B>** and select the desired airport using the small (⊕) and large (⊕) right knobs. Press **ENT** to accept the selected airport, then follow the steps in the preceding paragraph to select an approach for the new airport. See section 5 for more information on selecting and activating approaches.



A

Abbreviations158-160

Accessory listiii

Activating a flight plan20, 56, 58

Activating a flight plan leg60, 65

Activating a flight plan in reverse 56 ,58, 61

Activating an approach66-68

Active flight plan options60-63

Active frequency8, 22

Active leg28

Active to & from waypoints13

Active flight plan19, 54, 59

Addresses, GARMINi, iv

Airport approach page88, 96-97

Airport frequencies39-40, 86, 91-93

Airport information17, 35, 89-99, 115

Airport location page86, 89

Airport runway page86, 90

Airport type89

Airspace alert messages . .18, 119, 140, 142

Airspace information .34, 89, 119-122, 140

Altitude41, 45-48, 161

Altitude buffer140, 142

Approach procedures15, 66-85

Approaches . .15, 61, 63, 66-85, 94-95, 168

Approach available, at airport89

Arrivals15, 62, 86, 96-97

Arrival alarm141, 143

Automatic sequencing168

Automatic squelch1, 21

Automatic zoom32, 35-36

Auto-tuning22-25

AUX page group123-149

Aviation data (on map)35-36

B

Backlighting147-148

Bearing (BRG)161

Bearing measurements (on map)37

C

Cautionsii

CDI13, 28, 82, 127

CDI scale140, 142, 171

Checklists134

CLR (clear) key2, 10-11, 28, 32

Closest point of flight plan (FPL)63

COM configuration147-148

COM flip-flop key1, 8, 22, 114

COM power/volume knob1

COM squelch21

COM volume21

COM window8, 22-23

Contrast146-147

Conventions, manualv

Copying flight plans57-58, 61

Creating a flight plan19, 54, 58

Creating user waypoints104-106

Crossfill30, 58, 60, 125, 130

Cursor knobs1-2, 8

D

Data fields . . .9, 13, 29, 38, 42, 60, 63, 161

Date & time141, 145

Database confirmation page4

Database subscriptions4

Declutter map32

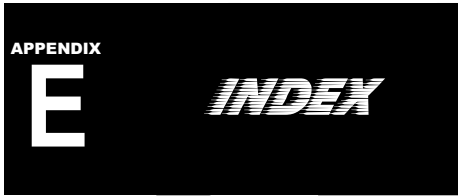

Default NAV page10, 13, 28-30
Deleting all flight plans 59
Deleting flight plans 57-59, 61
Deleting user waypoints 108-110
Density altitude125, 129
Departure time 135
Departures15, 86, 98-99
Desired track (DTK)161
Direct-to cancelling 53
Direct-to key .. 2, 12, 49-53, 65, 113, 170
Direct-to manual course selection 52
Direct-to navigation .12, 17, 34, 49-53, 113
Display backlighting146-147
Display contrast146-147
Distance (DIS) 161
Distance measurements (on map) 37
DME arcs76-78

DOP44, 46, 161
Duplex operations118
Duplicate waypoints 88

E

Editing flight plans 55, 64
Editing user waypoints106-107
Emergency channel select 26
ENT (enter) key 2
EPE 44, 46, 161
Emergency channel select 26
ETA (estimated time of arrival)161
ETE (estimated time en route)161

F

Field elevation 89
Flight plans19, 54-65
Flight plan catalog19, 54
Flight plan catalog options 58-59
Flight plan comments 56
Flight planning page123-131
Flight timers132-136
Foreword i
FPL (flight plan) key 3, 19
Frequency fields 8

Frequency selection8, 14, 22-26, 87,
.....114, 117, 118
Frequency usage restrictions 40, 92
Fuel planning124-131
Fuels available, at airport 89
Full screen map display 38

G

Generic timer135
Going to a nearest airport113
GPS receiver status 44-46
GPS window 8
Graphic track indicator 43
Ground speed (GS)162
Ground track (TRK)162

H

Hold (in an approach)73-75
Holding patterns169

I

Installation of NavData card 163
INTEG annunciation7, 133, 167
Intersections 86, 100
Inverting flight plans 56, 58, 61

K	
Key functions	.1-3
Knob functions	.1-2
L	
Land data (on map)	.35-36
Land data page	.7
Loading an approach	.66-69
Local time setting	.145
Locked waypoints	.147, 151
M	
Magnetic variation	.140, 143
Main page groups	.10, 11
Manual conventions	.v
Map datums	.141, 144, 165-167
Map declutter	.32
Map direct-to	.34
Map orientation	.35-36
Map page	.9-11, 27, 30-38
Map page options	.35-38
Map panning	.33
Map scales	.30-32, 90
Map setup	.32, 35-36
Max speed	.136

Measurement units	.140, 143
MENU key	.2
Message page	.7
Messages	.7, 149-156
Missed approaches	.71, 170
MSA (minimum safe altitude)	.41
MSG (message) key	.3, 7
N	
NAV page group	.10, 27-48
NAVCOM page	.10, 13-14, 39-40
NavData cards	.163
Navigation terms	.161-162
NDBs	.86, 101
Nearest airport page	.3, 16-17, 23, .111-115, 147-148
Nearest airspace	.3, 16, 18, 119-122
Nearest center (ARTCC) page	.3, 16, 24 .111, 117
Nearest FSS page	.3, 16, 24, 111, 118-119
Nearest intersection page	.3, 16, 111, 113
Nearest NDB page	.3, 16, 111, 112
Nearest user waypoints page	.3, 16, 111
Nearest VOR page	.3, 16, 111, 115, 116
NRST key	.3, 16, 111, 149



NRST page group	.3, 16, 111-122
-----------------	-----------------

O	
OBS key	.3, 72, 74, 169-171
Odometer	.136
Overzoom	.32

P	
Packing list	.iii
Page groups	.10, 11, 27, 86
Pointer, panning	.33
Position format	.141, 144
Position page	.10, 41-43
Power/volume knob	.1, 4
Power on (normal)	.4
PROC (procedures) key	.3, 15, 66
Procedure turns	.69-71



Procedures page15, 66-67
PUSH CRSR (small right) knob 2

R

RAIM prediction132, 133, 137, 167
RAIM protection limits140
Radar coverage information 89
Reference waypoint42, 104-105
Removal of NavData card163
Removing approaches63-64
Removing arrivals63-64
Removing departures63-64
Renaming user waypoints109
RNG (range) key 2
Roads (on map)35-36
Runway information 90

S

Satellite status page7, 10, 44-46
Scheduler messages126, 131
Scroll bar 3, 112
Selecting approaches61, 66, 68
Selecting arrivals62, 66
Selecting departures62, 66
Self-test (power-on)4
Setup 1 page123, 139-145
Setup 2 page123, 146-148
SIDs62
Signal strength46
Sky view46
Software/database versions133, 138
Sorting flight plans59
Specifications164
Standby frequency8, 22
STARs62
Stuck microphone26
SUSP annunciation72, 74, 169
Sunrise/sunset times133, 138
Squelch1, 21
Symbols, default NAV page28
Symbols, map page31

T

Table of contentsv-vi
Target pointer33
Terms161-163
3D GPS navigation45
Time141, 146
Timers132, 135-136
Track (TRK)162
Transitions66-85, 94
Trip planning130, 132
Trip statistics133, 136
Trip timer133, 136
True air speed126, 129
Tuning cursor22
Turn advisories69-85, 171
Turn anticipation171
2D GPS navigation45

U

Units of measure140, 143
User waypoint list108-109
User waypoint page86, 103
Utility page123, 132-138

V

Vectors-to-final	.67, 79-81
Vertical navigation (VNAV)	.46-48
Vertical navigation page	.10, 46-48
Volume	.1, 4, 21
VORs	.86
VSR (vertical speed required)	.162

W

Warranty	.iv
Waypoint alerts	.71-85, 171
Waypoint entry	.87
Waypoint holding	.169-170
Waypoint identifiers	.87
Waypoint list (user waypoints)	.108-109
Waypoint sequencing	.170
Weather broadcasts	.100, 102
Winds aloft	.126, 129
WPT page group	.86-110





© 1999-2000 GARMIN Corporation
1200 East 151st Street Olathe, KS 66062

GARMIN (Europe) LTD, Unit 5, The Quadrangle, Abbey Park Industrial Estate, Romsey, SO51 9AQ, UK

GARMIN (Asia) Corp., No. 68, Jangshu 2nd Road, Shijr, Taipei County, Taiwan

Web Site Address: www.garmin.com

Part No. 190-00140-20 Rev. B